



**Intelligent Assistants for Flexibility Management
(Grant Agreement No 957670)**

D2.4 Revised architecture of iFLEX Framework

Date: 2.6.2022

Version 1.0

Published by the iFLEX Consortium

Dissemination Level: PU - Public



**Co-funded by the European Union's Horizon 2020 Framework Programme for Research and Innovation
under Grant Agreement No 957670**

Document control page

Document file: D2.4 - Revised architecture of iFLEX Framework_v1.0.docx
Document version: 1.0
Document owner: VTT

Work package: WP2 User-centric service and system design
Deliverable type: R - Document, report

Document status: Approved by the document owner for internal review
 Approved for submission to the EC

Document history:

Version	Author(s)	Date	Summary of changes made
0.1	Anne Immonen, Jussi Kiljander (VTT)	2022-02-01	First draft, structure, functional view: description of AMF and DTR interfaces, information view: description of data items of AMF and DTR interfaces, refinement of building community iFA.
0.2	Isidoros Kokos, Nikos Charitos (ICOM)	2022-04-25	Functional View: Interfaces of the A&M and UI Modules, Information View: A&M and UI Modules, Household iFA: PUC-1 and PUC-4, 2 additional UCs regarding flexibility validation data and the Greek pilot
0.3	Klemen Stanič, Dušan Gabrijelčič	2022-04-25	Functional view: RAI, Weather and Trust, Security and Privacy. Information view: RAI, Weather and Trust, Security and Privacy. Household iFLEX Assistant functional view, Trust, Security and Privacy perspective. Minor other updates.
0.4	Andrej Krpič	2022-05-25	iFA context view for households.
0.5	Anne Immonen, Jussi Kiljander (VTT)	2022-05-25	Minor modifications Prepared for internal review
1.0	Anne Immonen, Jussi Kiljander (VTT)	2022-06-02	Final version submitted to the European Commission

Internal review history:

Reviewed by	Date	Summary of comments
Arso Savanović (SCOM)	2022-05-27	Accepted with minor comments.
Poria Divshali (Enerim)	2022-05-31	Accepted with minor comments.

Legal Notice

The information in this document is subject to change without notice.

The Members of the iFLEX Consortium make no warranty of any kind with regard to this document, including, but not limited to, the implied warranties of merchantability and fitness for a particular purpose. The Members of the iFLEX Consortium shall not be held liable for errors contained herein or direct, indirect, special, incidental or consequential damages in connection with the furnishing, performance, or use of this material.

Possible inaccuracies of information are under the responsibility of the project. This report reflects solely the views of its authors. The European Commission is not liable for any use that may be made of the information contained therein.

Index:

1	Executive summary	5
2	Introduction	6
2.1	Requirements for the common iFLEX framework	6
2.2	Overview of the followed standards and best practises	6
2.3	Description of the design process	6
2.4	Content and structure of this document	7
3	Architecture for the common iFLEX Framework	8
3.1	Context view	8
3.2	Functional view	10
3.2.1	Description of functional components	10
3.2.2	Interfaces of the functional components	14
3.3	Information view	17
3.3.1	Overview	17
3.3.2	Aggregator and Market Interface	19
3.3.3	Automated Flexibility Manager	22
3.3.4	Digital Twin Repository	23
3.3.5	End-user Interface	24
3.3.6	Resource Abstraction Interface	27
3.3.7	Weather Service Interface	27
3.3.8	Trust, Security and Privacy Interface	28
3.4	Interoperability perspective	30
3.5	Security and privacy perspective	31
4	Architectures for domain specific iFLEX Assistants	33
4.1	Architecture of an iFLEX Assistant for households	33
4.1.1	Context view	33
4.1.2	Functional view	34
4.2	Architecture of an iFLEX Assistant for a building community	48
4.2.1	Context view	48
4.2.2	Functional view	50
5	Conclusion	56
6	List of figures and tables	57
6.1	Figures	57
6.2	Tables	57
7	References	59
8	Appendix	60

Abbreviations and acronyms

Abbreviation	Description
A&M	Aggregator and Market
AFM	Automated Flexibility Manager
BEMS	Building Energy Management System
BUC	Business Use Case
CO2	Carbon dioxide
DER	Distributed Energy Resource
DH	District Heating
DRMS	Demand-response Management System
DTR	Digital Twin Repository
EMS	Energy Management System
EV	Electric Vehicle
FMI	Finnish Meteorological Institute
FTP	File Transfer Protocol
HEMS	Home Energy Management System
HLUC	High Level Use Case
iFA	iFLEX Assistant
MLOps	Machine Learning operations
MQTT	Message Queuing Telemetry Transport
PUC	Primary Use Case
PV	Photovoltaics
PL API	Programming Language Application Programming Interface
RAI	Resource Abstraction Interface
SGAM	Smart Grid Architecture Model
SGIS	Smart Grid Information Security
SenML	Sensor Measurement List
VPP	Virtual Power Plant

1 Executive summary

This document describes the common architecture for the iFLEX Framework. The architecture design is an iterative process consisting of three phases. This document describes the second phase of the design process.

The architecture consists of different views and perspectives. The context view describes how the iFLEX assistant (iFA) interacts with end-users, other stakeholders and its environment. The functional view describes the division of iFA into logical subcomponents and the interactions between these sub-components. The information view describes how the components process and manage information, and the deployment view describes how the iFA can be configured, packaged and deployed into energy services provided to the end-user. Interoperability perspective describes how the different components interact for a particular purpose to reach a common goal, whereas security, scalability and privacy perspectives ensure that the non-functional requirements are properly addressed by the iFLEX Framework architecture.

In the first phase, the context view, the functional view and the information view were defined, and the interoperability, security and privacy perspectives were documented, as these were recognized as the most apparent. In the first phase, also an instantiation example of the iFlex Assistant was provided by applying the common context and functional views to the Finnish pilot.

In the second phase, the functional view is refined by describing the interfaces for each component (including the functions the interface implements). In addition, the information view is refined by describing each data item in more detail. The iFLEX Assistant is also applied to households, describing a common instantiation example of the iFlex Assistant for both Slovenian and Greek cases. In addition, the context and functional views between different applications of the iFA (for households and building communities) are compared and the common parts of the iFLEX framework are refined.

2 Introduction

2.1 Requirements for the common iFLEX framework

This work takes the identified requirements (defined in deliverables D2.1 and D7.1) as input for the design of the common architecture for the iFLEX Framework. These include:

- business requirements
- end-user requirements
- system requirements
- security requirements
- socio-economic requirements, and
- functional requirements – use cases and pilots.

These requirements will be elaborated in the next project iteration, and the more detailed requirements will be documented in the project deliverables of WP3 and WP4.

2.2 Overview of the followed standards and best practises

The iFLEX architecture design follows the ISO/IEC/IEEE 42010:2011 standard (ISO, 2011) in the architecture documentation, which is an international standard addressing creation, analysis and sustainment of architectures of systems. The standard specifies required contents of an architecture description, such as the de-facto stakeholders and views. In addition, the iFLEX architecture design uses the architectural perspectives (Rozanski and Woods, 2014) to ensure the particular set of related quality properties across the architectural views.

The iFLEX architecture will also be aligned and mapped to the CEN-CENELEC-ETSI Smart Grid Reference Architecture (CEN, 2012) and the associated flexibility management concepts. In March 2011, the European Commission and EFTA issued the Smart Grid Mandate M/490 which was accepted by the three European Standards Organizations; CEN, CENELEC and ETSI. In the context of Mandate M/490, a holistic viewpoint of an overall architecture; Smart Grid Architecture Model (SGAM), was developed. The main components of the Reference Architecture are: 1) European Conceptual Model: An evolution and extension of the NIST Smart Grid model, which takes Europe specific requirements into account. The main extension is the of distributed energy resources (DER). 2) Architecture Viewpoints: SGAM utilizes following viewpoints in the architecture documentation: Business, Function, Information, Communication and Component. 3) SGAM Framework: Provides support for the design and development of Smart Grids systems. The framework takes into account already identified relevant aspects such as interoperability (e.g. the GridWise Architecture Council Stack (Council, 2008), multi-viewpoints (SGAM Layers) and provides a functional classification on required and available data models, interfaces and communication layers. The iFLEX architecture design utilises the Interoperability dimensions of SGAM, especially information and communication layers for syntactic and semantic interoperability.

2.3 Description of the design process

The architecture design is an iterative process implemented in three phases. These phases follow the planned pilot phases (see the Grant Agreement):

- Phase 1: A pre-pilot with the Minimum Viable Product of the iFLEX Framework and Assistants are carried out with selected users.
- Phase 2: A small-scale pilot including the iFLEX Framework with full functionality are validated with small-scale pilot groups.
- Phase 3: The improved iFLEX Framework are deployed and validated in large-scale pilots.

A common architecture is first designed for the common iFLEX Framework. Then, more detailed descriptions are defined for each of the different types of iFLEX Assistants (iFAs) (households, building communities). Finally, the commonalities of those descriptions are generalized back to the common iFLEX architecture. Architecture design begins by identifying how the iFA interacts with end-users, other stakeholders and its

environment (i.e., context view). After that, the iFA is divided into logical subcomponents (i.e., functional view), and the interactions between the sub-components are described. The component specific requirements are identified after the functional decomposition of the architecture. The list of requirements will be added as an appendix to this deliverable in later phases. After component definition, it is defined how these components process and manage information (i.e., information view). Finally, the deployment view describes how the iFA can be configured, packaged and deployed into energy services provided to the end-user. Interoperability perspective is described to understand how the different components interact for a particular purpose to reach a common goal. Security and scalability perspectives will be documented to ensure that these non-functional requirements are properly addressed by the iFLEX Framework architecture.

In the first phase, the following views and perspectives were recognized as the most apparent: Context view that describes how the iFLEX framework interacts with its environment, functional view that describes the common functionalities of the iFLEX framework (with the help of use cases) and the information view that identifies the data items that the iFLEX framework manages. In addition, the interoperability perspective was described that identifies the technologies and standards for different interoperability layers of the iFLEX framework, and the security and privacy perspectives that describe the approach and means to fulfil the security and privacy requirements. Furthermore, an application of the iFA to building communities was described in the first phase as an instantiation example with applied context view and more specific and detailed functional view.

In the second phase, the architectural work concentrates on improving the functional and information views. In the functional view, the interfaces for components are described by defining the functions that each interface implements. The information view is refined by describing the data flow between the functional elements in more detail. This includes the detailed description of each data item of each interface. The iFA is also applied to households, describing a common instantiation example of the iFlex Assistant in Greek and Slovenian pilots. The context and functional views between different iFAs (applied to households and building communities) are compared and the common parts of the iFLEX framework will be refined.

In the third phase, deployment view will be defined, describing the how the iFA is configured, packaged and deployed. The iFLEX framework will be deployed with the help of the pilots (one building community and two households) and validated.

2.4 Content and structure of this document

This document is structured as described in the following. Section 3 describes the architecture for the common iFLEX framework, including context, functional and information views, and interoperability, security and privacy perspectives. Section 4 describes the applications of iFLEX Assistants both for households and for a building community. Finally, section 5 concludes the work.

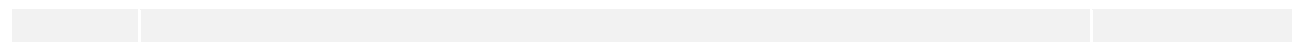

3 Architecture for the common iFLEX Framework

This section describes the architectural views and perspectives common to all pilots.

3.1 Context view

Context view typically describes a system in its environment with the related external actors that interact with it. Figure 1 presents the actors, the elements and the relationships of the iFLEX Framework in the context view. The detailed description of the elements is represented in Table 1.

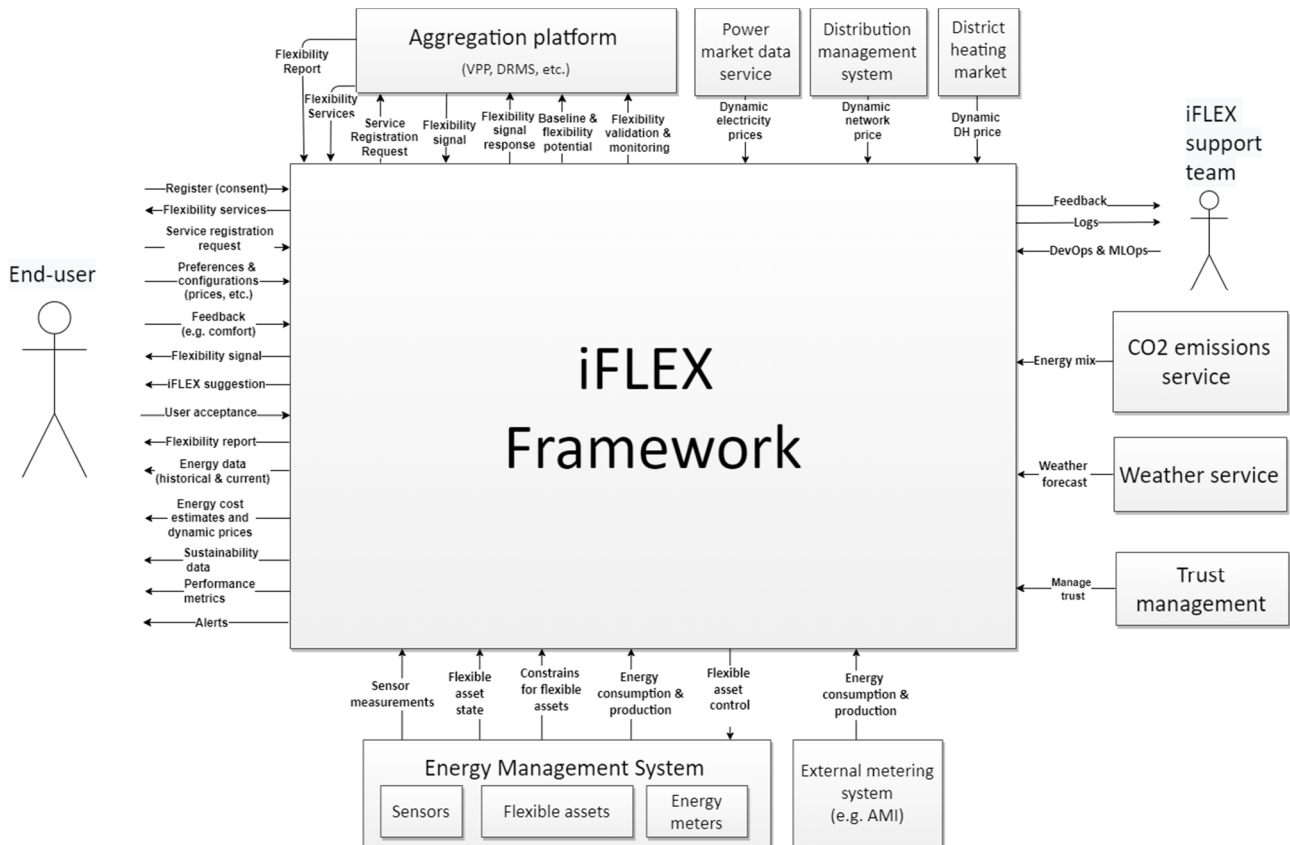

Figure 1: The common context view of the iFLEX Framework.

Table 1: Description of elements of the context view.

Element	Description	Managed data
Sensor	A device that measures certain variables (e.g. temperature) within the end-user’s premises	Sensor measurement data
Energy meter	A device that provides near real-time metering data about energy flows of flexible/non-flexible assets or of the whole facility.	Energy consumption and production data
Flexible asset	Dispatchable unit (e.g. residential PV system, controllable home appliance, energy storage, EV) that can be controlled via the EMS.	<ul style="list-style-type: none"> Energy consumption and production data Flexible asset state Constraints for flexible asset
Energy management system (EMS) <ul style="list-style-type: none"> Home energy management 	<ul style="list-style-type: none"> Monitors the energy flows of the building Provides information about energy consumption and production, and the state of the flexible asset Controls the building’s energy resources (devices, flexible asset) according to control commands 	<ul style="list-style-type: none"> Sensor measurement data Energy consumption and production data Flexible asset state

Element	Description	Managed data
system (HEMS) <ul style="list-style-type: none"> Building energy management system (BEMS) 		<ul style="list-style-type: none"> Constraints for flexible asset Flexible asset control
Weather service	Provides weather data	Weather data (current, history)
Power market data service	Provides current electricity market data	Dynamic electricity price
iFLEX Assistant (iFA)	The system under design. <ul style="list-style-type: none"> Learns from the consumption behaviour of the end-users. Predicts and analyses the consumption of DERs. Calculates and suggests relevant flexibility services based on the information from sensing devices, external services and the preferences and behaviour of the end-user. 	<ul style="list-style-type: none"> Flexible asset control Feedback data Logs data Service registration request Flexibility signal response Baseline and flexibility potential Flexibility validation and monitoring Flexibility services Flexibility signals iFlex suggestions Flexibility report Energy data (historical and current) Energy cost estimates and dynamic prices Sustainability data Performance metrics Alerts
End user	The end-user of the iFA. Could be an individual resident or a facility manager. Provides: <ul style="list-style-type: none"> Preferences and configuration Feedback on operation of the assistant Authorization/Consent to assistant's activities Receives: <ul style="list-style-type: none"> Demand-response notifications Advices on energy efficient behaviour Visualizations of energy, cost and sustainability metrics. 	<ul style="list-style-type: none"> Service registration request Register (consent) and configurations Preferences and configurations Feedback data User acceptance
Aggregation platform (electricity retailer, district heating provider, energy service provider)	A solution for aggregating and managing flexible resources (e.g. DRMS, VPP). <ul style="list-style-type: none"> Receives flexibility offerings by the iFA Activates flexibility according to the preferences of the end-user 	<ul style="list-style-type: none"> Flexibility report Flexibility services Flexibility signals
Distribution management system	Provides the current distribution network prices	Dynamic network prices

Element	Description	Managed data
District heating market	Provides the current district heating prices	Dynamic district heating prices
CO2 emission service	Provides data about the equivalent CO2 emissions	Energy mix
iFLEX support team	Collects feedback from end-users and manages software of iFLEX system	DevOps & MLOps
External metering system	External metering system that provides data about energy consumption and production	Energy consumption and production data
Trust management	Enables establishing trust among entities in the system. Enables recognition of end user identities, their credentials, corresponding resources and their relation to roles in the system. Allows for giving end user a consent to a data controller. Trust between end-users and iFA is established through the process of enrolment. Trust is provided by a combination of a modern identity management approach, where the user is in control of their own identity, and established trust management practises.	Manage trust

3.2 Functional view

The functional view describes the components and their interfaces.

3.2.1 Description of functional components

Figure 2 describes iFLEX Framework as elements, relationships and their responsibilities. In Table 2, the use cases are mapped to the elements that implement them. One use case can be mapped to several elements.

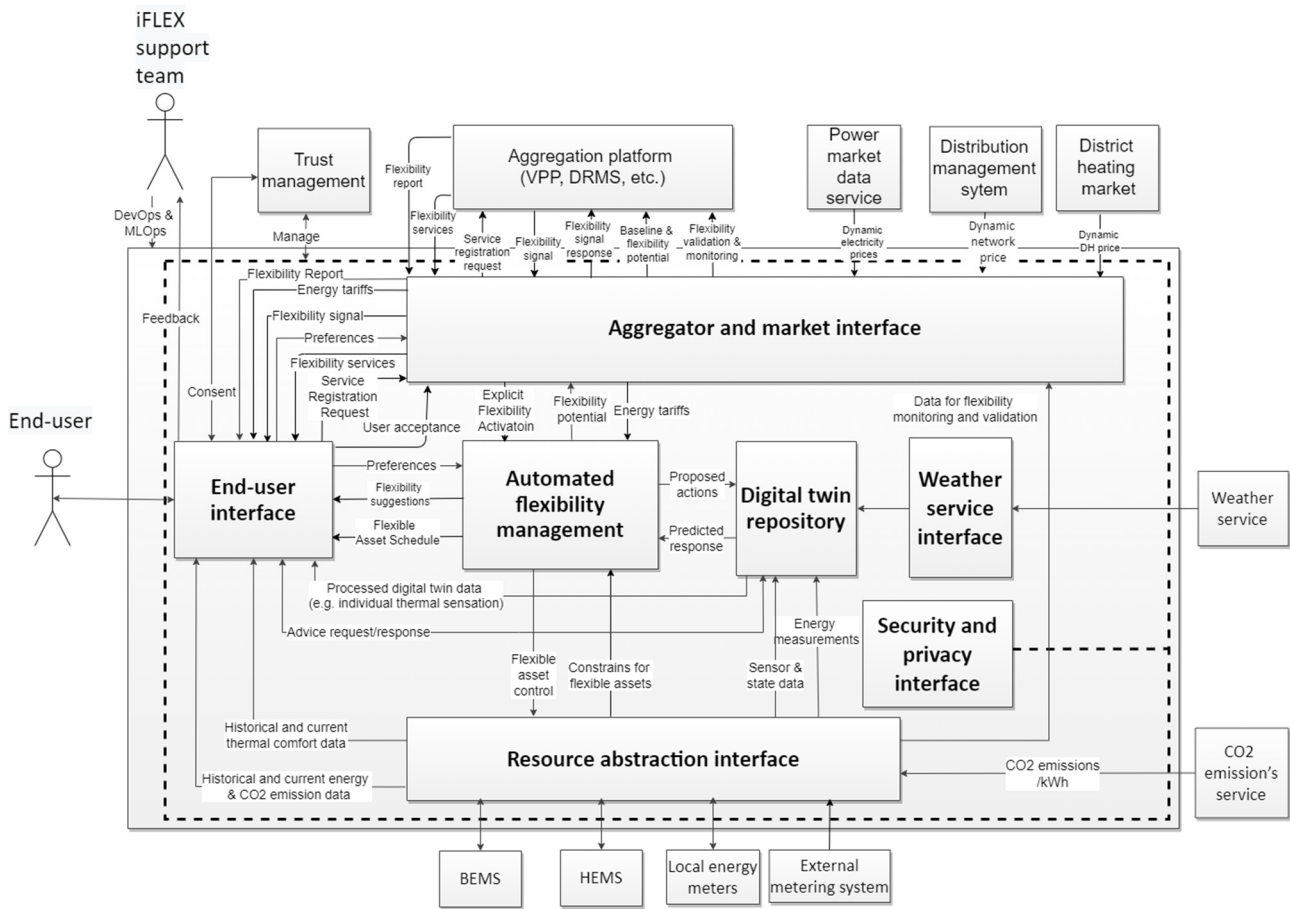

Figure 2: Functional view of the common iFLEX Framework.

Table 2: Functional elements of the common iFLEX Framework

Element	Functional description	Managed data
<p>End-user interface</p> <ul style="list-style-type: none"> • Resident • Facility manager 	<p>Define comfort levels: The end-users will be able to select among predefined modes and customise them according to their preferences. (PUC1)</p> <p>Flexibility management policy: The assistant will offer a prioritization of end-user motives for proposing the optimal schedule(s) of devices operations. Based on the flexibility management policy selected by the user, the assistant will automatically process with the selection/execution of the ‘best’ control action schedule. (PUC1)</p> <p>Communication personalization: End-users will be granted the capability to customise their interaction with the iFA according to their preferences. (PUC1)</p> <p>Providing feedback: End-users are able to provide feedback about their residential conditions any time. (PUC1)</p> <p>Performance management: The end-user can set goals on the performance of their installed devices in relation to chosen metrics such as sustainability, energy consumption and cost savings. (PUC7)</p> <p>Flexibility service registration: End-user expresses interest for flexibility service, and retrieves a list of current and relevant services. (PUC6)</p> <p>Approve actions: The end user provides consent for sharing information with third parties:</p> <ul style="list-style-type: none"> • on sharing baseline load and flexibility information with the aggregator. (PUC8) <p>One also is able to approve:</p> <ul style="list-style-type: none"> • Flexibility suggestions (e.g. load rescheduling) provided by iFA • DR events (including opt-in/out response) • Notifications, alerts, advice (PUC1) (PUC5) <p>Visualising:</p> <ul style="list-style-type: none"> • Sustainability metrics and goals (PUC3) • Advice, notifications, alerts (PUC1) (PUC5) (PUC7) • Short and long term consequences of the advices (PUC5) • User participation and engagement reports (PUC4) (PUC5) • Energy consumption/production (real-time data, historic (trends) data) (PUC7) <p>Control iFLEX Assistant properties: The preferences of end-users are fine-tuned (PUC5)</p>	<ul style="list-style-type: none"> • User acceptance • Preferences • Static price data • Feedback data • Service registration request • Consent
<p>Resource abstraction interface</p> <ul style="list-style-type: none"> • BEMS • HEMS • Metering interface 	<p>Fetching data from sensors: Smart meter, submeter, temperature sensor (PUC2) (PUC8) (PUC9)</p> <p>Provide setpoints of operation to local dispatchable assets: Residential PV systems, home appliances, energy storage systems, EVs (PUC2)</p> <p>Controlling the operation of dispatchable devices and assets: The devices and assets are controlled according to the selected policies/schedules (PUC1) (PUC9)</p> <p>Unifying access to fetched data: provide northbound unified access to fetched data to other iFA components (PUC2) (PUC3) (PUC4) (PUC5) (PUC7) (PUC9) (PUC10)</p>	<p>History of energy consumption and CO2 emission data</p> <p>History and current thermal comfort data</p> <p>Constraints for flexible assets</p> <p>Sensor and state data</p> <p>Energy measurements</p> <p>Data for flexibility monitoring and validation</p>

Weather service interface	Fetching weather data: Provide unified access to fetched weather data (PUC2) (PUC8) (PUC9)	Weather data
Aggregator and market interface	The interface will support seamless interaction between the iFA and the market (PUC2), providing access to publicly available market data, communication of flexibility signals (incentives) and preferences for flexibility provision. It will also enable historical tracking of the measured flexibility offered to support transparent documentation of fair remuneration and rewards by the flexibility providers.	Energy tariffs Flexibility signal Flexibility services Flexibility signal response Service registration request Baseline and flexibility potential Flexibility validation and monitoring
Automated flexibility management	<p>User engagement evaluation and reporting: Manage participation reports, calculate participation and rewards, evaluate engagement, prepare reports, visualize reports (PUC4)</p> <p>Electricity consumption and performance analysis: Providing detailed analysis of the electricity consumption and performance (real-time and historic) (PUC7)</p> <p>Calculate relevant services: Calculating and updating the list of relevant services (to be offered for end-users) (PUC6)</p> <p>Analyse and calculate savings, forecast, simulate: Advises are formed to end-users to reduce energy consumption and reach the goals (PUC5)</p> <p>Engage end-user in energy advice: Keeps track of the decision success and evaluates the engagement after the end-user has chosen an advice to follow (PUC5)</p> <p>Offer flexibility: The baseline load profile is forecasted with the help of information from sensing devices, external services and the preferences and behaviour of the consumer/prosumer. The baseline load profile and associated flexibility offers are provided to the aggregator. (PUC8)</p> <p>Flexibility management policy: Based on the flexibility management policy selected by the user, the assistant will automatically process with the selection/execution of the 'best' control action schedule. (PUC1)</p> <p>Providing the end-user with an optimal energy scheduling: Exploiting past experience to come up with an optimized energy schedule for the premises. The calculation/acceptance the schedule(s) are communicated to the EMS, which controls the operation of dispatchable devices and assets (PUC9)</p>	Flexibility suggestions Flexibility signal response Baseline and flexibility potential Flexible asset control Proposed actions
Digital twin repository	Develops and tests predictions by modelling user behaviour and energy systems. Stores the models and predictions.	Predicted response

Security and privacy interface	Provides a number of security and privacy mechanisms: <ul style="list-style-type: none"> • Communication security among the external subsystems and the iFA; data origin authentication and integrity services are provided together with confidentiality services in communication • Authenticates entities in communication and extracts and validates their identities, roles and claims with attributes • Authentication, Authorization and Accounting for access from external entities to the iFA interfaces, administrative border is denoted with a dashed line in Figure 2. • Provides confidentiality, integrity of the data stored in the iFA and availability of the services providing the access, • Provides security of the iFA at rest 	Trust management data Identities Identity data Credentials Access control policies
--------------------------------	---	--

3.2.2 Interfaces of the functional components

3.2.2.1 Aggregator and Market Interface

The interface of the A&M Module is a REST API, namely it conforms to the REST architectural styles¹. The resources of the A&M interface are presented in Table 3.

Table 3 Resources of the A&M interface

Resource	Method	Description
Flexibility Signal	REST API	This resource is used for providing the AFM and UI Modules with information relevant to explicit and implicit DR events. Amongst the communicated data are the date and time of the received flexibility signal, the status and time intervals of the DR event, as well as the requested user action in each one of these intervals in case of explicit DR events.
Flexibility Signal Response	REST API	This resource is used for providing the external Aggregation Platform with the response to an explicit DR event according to the predefined communications protocol (e.g. OpenADR 2.0b ²). The response can be either manual (user-generated via the UI) or automated (iFLEX-generated via the AFM).
Flexibility Validation Data	REST API	This resource concerns the validation of offering flexibility. The data are originally retrieved from the RAI and are then exposed to the external Aggregation Platform. Validation data can be either energy measurements from smart meters and/or sub-meters or data concerning the operation state of specific assets. This depends on the specifications of each flexibility service (aka DR program).
Participation Assessment	REST API	This resource concerns the assessment of the iFA end user's compliance of actions with the DR event requirements. The A&M performs this task and exposes the outcome (i.e. successful – or not – participation) to the external Aggregation Platform as a value-added service.
Flexibility Report	REST API	This resource concerns the reports linked to explicit DR events. The report is generated by the external Aggregation Platform and forwarded to the UI Module.

¹ <https://restfulapi.net/>

² <https://www.openadr.org/specification>

Energy Tariffs	REST API	This resource concerns the various energy tariffs (e.g. retail electricity, network electricity, district heating). Relevant data are retrieved from external energy market interfaces and forwarded to the AFM and UI Modules. Includes information on type of tariff, resolution, time intervals, and value per unit of energy.
----------------	----------	---

3.2.2.2 Automated Flexibility Manager

The Automated Flexibility Manager interface is based on publish-subscribe type of communication pattern and implemented on top of MQTT. Table 4 lists the resources of the AFM interface.

Table 4: Resources of the Automated Flexibility Manager interface.

Resource	Method	Description
Flexibility Potential	MQTT Subscribe	By subscribing to this resource, the client (i.e., A&M Interface) is notified about the flexibility potential. The potential includes forecast on 1) the up and down flexibilities and 2) baseline loads, as well as 3) flexibilities that have been agreed to be activated in each period of the forecast window. The flexibility potential message is used in two ways. First, it is updated periodically to notify A&M Interface about the latest flexibility and baseline forecast. Second, it is used as a response to the Explicit Flexibility Activation (the agreed flexibilities parameter specifies the amount of flexibility that is estimated to be activated).
Explicit Flexibility Activation	MQTT Publish	The client can activate flexibilities managed by the AFM by publishing a flexibility activation message to this resource.
Flexible Asset Schedule	MQTT Subscribe	This resource enables client to subscribe to changes in the flexible asset schedule. Separate channel is used for each flexible asset.
Load Measurement	MQTT Subscribe	This resource allows client to subscribe to load measurements collected by the AFM. Load measurements can be used for estimating the reliability and accuracy of the baseline and flexibility forecasts.

3.2.2.3 Digital Twin Repository

The Digital Twin Repository interface, presented in Table 5, is implemented as a programming language API.

Table 5: Logical interface of the Digital Twin Repository.

Resource	Method	Description
Predict Request/Response	Python API / REST API	This resource is used for requesting a prediction from the Digital Twin Repository. The prediction request specifies the desired load levels for each period. In no load is specified then a baseline load is assumed. The response of the API call specifies the predicted response of the consumer given.

3.2.2.4 End-user Interface

The interface of the UI Module is a REST API. The resources of this interface are presented in Table 6.

Table 6 Resources of the UI Module

Resource	Method	Description
----------	--------	-------------

Event Acceptance	REST API	This resource is used for communicating the iFA end user's response to a DR event to the A&M and AFM Modules. Relevant information includes the date and time of the response, the response itself and potential updates, the DR event linked to the response, as well as whether the response is manual (user-generated) or automated (iFLEX-generated).
iFA Suggestion Acceptance	REST API	This resource concerns the end user's response to iFLEX-generated suggestions. The data are communicated to the AFM Module. Amongst the information are the response and potential updates, date and time of the response, the iFLEX suggestion to which the response is linked, as well as whether the response is manual or automated.
Objective	REST API	This resource communicates to the AFM Module the active optimisation objectives, as selected by the iFA end user.
User Schedule Preference	REST API	This resource communicates the preferred schedules, as set by the iFA end user, to the A&M and AFM Modules. Relevant information includes the days on which a schedule is active, the involved assets and the temporal and operational constraints for each one of them, as well as whether these constraints are flexible or not.

3.2.2.5 Resource Abstraction Interface

Resource Abstraction Interface (RAI) is implemented in part as REST API and in part as a publish subscribe interface (see Table 7). The REST API enables access to historic data fetched through the RAI. Publish subscribe interface allows access to real time data, state of the devices and their control capabilities. In this table they are described from RAI service point of view. The interfaces are stated at their coarse granularity, for security and privacy purposes they will be more fine grain, allowing to control access per device.

Table 7: Logical RAI interfaces

Resource	Method	Description
AMI interface	REST/PUT	The interface allows posting smart metering historic data in the RAI. The data is assumed to be historic as a day minus one data.
Consumption interface	REST/GET	The interface allows accessing historic data per device, household, building and smart meter in a specified timeframe and granularity. Foreseen granularity is from few seconds, where available, to regular 15 minutes, 1 hour, day etc. If the reporting interval is larger than the granularity of underlying data basic statistics like maximums, minimums and standard deviation are provided for the interval as well.
Devices	Publish	The interface allows subscribing to a topic providing household or building information on devices to collect information about the devices, their capabilities and limitations installed at the premises.
Devices measurements	Publish	The interface allows subscribing to the topic providing devices measurements at the household or building level. A number of various measurements is supported, like power, energy, temperature, etc.
Devices state	Publish	The interface allows subscribing to a topic providing information from a household or a building on devices state. Multiple state types are supported, like on/off, on/pause/off, etc.
Devices control	Subscribe	The interface allows publishing information on desired device actions, like turning the device on or off.

3.2.2.6 Weather Service Interface

The weather service interface (see Table 8) is implemented as a REST API. It allows accessing historic weather data as well the weather forecast, if available.

Table 8: Logical weather interface

Resource	Method	Description
Weather interface	REST/GET	The interface allows accessing historic and forecast weather data for specified time interval and location.

3.2.2.7 Security, Trust and Privacy Interface

Security, Trust and Privacy Interface is responsible for management of trust in the system, identification of end-users, secure communications and control of access to resources. This is achieved through a cooperation of inter-connected modules. In order for the end-user to participate in the iFA pilot, he must first go through a multi-step process: First the end-user needs to create an identity. With the created identity, the end-user goes through the process called enrolment, where trust, access control policies and secure communication is established. Finally, the user can access their resources or control their devices. The interfaces needed to achieve this functionality are provided in the Table 9.

Table 9: Logical interface of the Security, Trust and Privacy Interface.

Resource	Method	Description
Create Identity	Python API	End-users (iFA project participants, Flexibility Managers, etc.) use the interface to create their digital identities, representing them as an entity in the system. Identities are used for trust establishment.
iFA Enrolment	Python API	End-users present their Digital Identities to the Enrolment module. At the same time they assert a token, provided to them in the initial project invitation. The token serves as a binding between iFA deployment at the household/building and the digital identity, created by the end user. Digital identity is linked to a predefined end-user account and a credential, used to authorize the user, is issued to the end-user. Relevant access control policies and means of secure communications are created.
Access Delegation	Python API	The interface can be used to authorize an end-user to access the authorizer data or to control their devices.
Access Revocation	Python API	End-users can revoke previously given access control delegations to other end-users.
iFA data	Python API	Upon a request the interface returns the data collected on behalf of an end user to the end user
iFA Cancellation/Exit	Python API	Upon the end-users request to end their participation in the iFA project, relevant end-user's data and access policies are deleted.
Access Control	REST API	The interface allows querying for a permission if a requesting entity has access to a certain resource (data, control) of an entity/owner. Access control of specific resources is managed by the access control policies. When a specific resource is requested by the end-user, his identity, role or delegated authority is checked against the policies and a decision is made to allow or deny the operation.

3.3 Information view

The information view describes how the information is processed and managed by the components.

3.3.1 Overview

Table 10 **Error! Reference source not found.** summarizes the identified data elements of the iFA.

Table 10: The data elements of iFLEX Assistant.

Units	Data types	Resources	Systems	Information/ knowledge
-------	------------	-----------	---------	---------------------------

<ul style="list-style-type: none"> •Power, energy, capacity, ... •Temperature, humidity, CO2,... •Location 	<ul style="list-style-type: none"> •Measurement •Flexibility data •State data •Weather data •Market data •Feedback data •Maintenance data •Report •Analysis and forecast data •Alerts and acknowledgement •Control data •Constraint • End-user data 	<ul style="list-style-type: none"> •Sensors •Flexibility assets •Energy metering 	<ul style="list-style-type: none"> •Distribution management system •District heating management system •Power market data service •Energy management systems (BEMS, HEMS) •Third party services (e.g. weather service, CO2 emission service) •Aggregator’s systems 	<ul style="list-style-type: none"> •Common measurements and baseline •Building/home specific data •End-user specific data •Models (digital twins) •Offerings description •Flexibility service description •Contracts Identities •Credentials •Policies •Consents •Laws, standards •Market rules
---	--	---	--	--

The data items identified in the context view and the functional view are described in more detailed in Table 11.

Table 11: The description of data items.

Data item	Description	Data type
Sensor measurement data	Data that is produced by sensors in end-user’s premises. E.g., temperature and humidity.	Measurement data
Energy consumption and production data	Data about energy consumption and production of flexible asset (historical and current) to be visualised to end-user	Measurement data
Flexibility validation and monitoring	Relevant energy metering and/or flexible asset state information that can be used to monitor the situation during flexibility management and to validate the flexibility management event (e.g. to compare measured consumption to the baseline and activated flexibility)	Measurement data
Performance metrics	The performance metrics that are visualized to the end-user. The visualization is related to the end-user’s goals visualization and is guided according to the user preferences.	Measurement data
History and current thermal comfort data	Data about the historical and current thermal comfort (collected by the EMS) provided to the end-user.	Measurement data (report)
Energy measurements	The required energy measurement (consumption, production) for the future prediction with the help of digital twin.	Measurement data
Energy mix	Data about the emissions (e.g., CO2) provided by a third party service provider.	Measurement data
Sustainability data		
Flexibility signals	A signal to inform iFA about a flexibility. Flexibility signal can be either an explicit DR event (i.e., activation of flexibility potential) or an implicit DR event (i.e., dynamic price information).	Flexibility data
iFLEX (flexibility) suggestions	A proposal for the end-user to modify a schedule or setpoint of flexible assets. iFLEX suggestions need to be approved (User acceptance signal) before they are taken into account by the iFLEX Assistant.	Flexibility data
Flexibility report	Report on flexibility event results (e.g. rewards, cost-reductions, etc.).	Flexibility data
Flexibility services	A list of available services for end-users.	Flexibility data
Flexible asset state	Data about the current state of the flexible asset.	State data
Weather data	Data about the weather (current, historical).	Weather data

Energy cost estimates	Estimates (not official) of end-user energy costs based on consumption and energy price data (possibly for different energy vectors).	Market data
Dynamic district heating (DH) prices	The current district heating price defined by district heating operator.	Market data
Dynamic network prices	The current network price defined by network operator.	Market data
Dynamic electricity price	The current electricity price defined by electricity provider.	Market data
Static price data	Information on end-user energy and network fees. This information is used to estimate the energy costs.	Market data
Energy tariffs	Includes all the energy related tariffs, such as dynamic electricity price, network price and district heating price.	Market data
Feedback data	End-users' feedback about the residential comfort.	Feedback data
Logs data	Logging data from different functional components for debugging and maintenance purposes.	Maintenance data
DevOps&MLOps	Software updates and maintenance information.	Maintenance
History of energy consumption and CO2 emission data	Data about the historical consumption and CO2 emissions (collected by the EMS) provided to the end-user.	Report
Baseline and flexibility potential	The available flexibilities and baseline load profile at different time periods (learnt from the consumption behaviour of the user and the dynamics of relevant energy systems) that is exposed to the market actors.	Analysis data
Proposed actions	A request for the Digital Twins to predict the system response with respect to specific flexible asset control commands.	Forecast request
Predicted response	Response to the proposed actions (modelled with the help of the digital twins)	Forecast
Alert	An alert that is sent to end-user according to certain (predefined) events e.g., the power consumption exceeds a certain predefined threshold.	Alert
Flexibility signal response	An acknowledgement of the flexibility signal.	Acknowledgement
Flexible asset control	The control commands for the flexible asset that are used to control the assets according to schedules.	Control data
Constraints for flexible asset	Description of current constraints of the flexible asset.	Constraint
Preferences and configurations	A set of operational constraints and configuration of communication with iFA defined by the end-users.	End-user data Configuration data
Service registration request	End-user's expression about his/her interest to register to a service.	End-user data
Register (consent)	A message from end-user to register to the iFLEX Assistant. Registration process includes the informed consent of the end-user that is required for collecting, storing and processing data under GRPR.	End-user data (registration/ informed consent)
User acceptance	End-user's acceptance on iFLEX suggestions.	End-user data
Manage trust	End-user identity and related security interface data, access control policies, consent.	End-user data

3.3.2 Aggregator and Market Interface

The data objects relevant to the Aggregator and Market Interface are presented in Table 12, while the data models and their relationships are presented in Figure 3 and Figure 4.

Table 12: Data objects relevant to the A&M Interface Module

Data item	Description
Flexibility Signal	This data object describes the signal informing the iFA about explicit or implicit DR events.
Event Signal Type	This data item further elaborates the specifications of a Flexibility Signal.
Explicit/Implicit DR Event	These data items contain additional information relevant only to explicit/implicit DR events.
Flexibility Signal Response	This class describes the response of an end-user of the iFA to a Flexibility Signal, which concerns an explicit DR event.
Flexibility Report	The Flexibility Report contains the necessary information regarding the assessment of the iFA end user's participation in an explicit DR event.
Flexibility Validation Data	This data object is related to the validation of the iFA end user's compliance with respect to the requirements of an explicit DR event.
Energy Data	This data item elaborates Flexibility Validation Data, which concern energy measurements.
Asset State	This data item elaborates Flexibility Validation Data, which concern the operation state of an asset.
Energy Tariffs	Describes the various energy tariffs (retail electricity, network electricity, district heating) of the iFA end user.

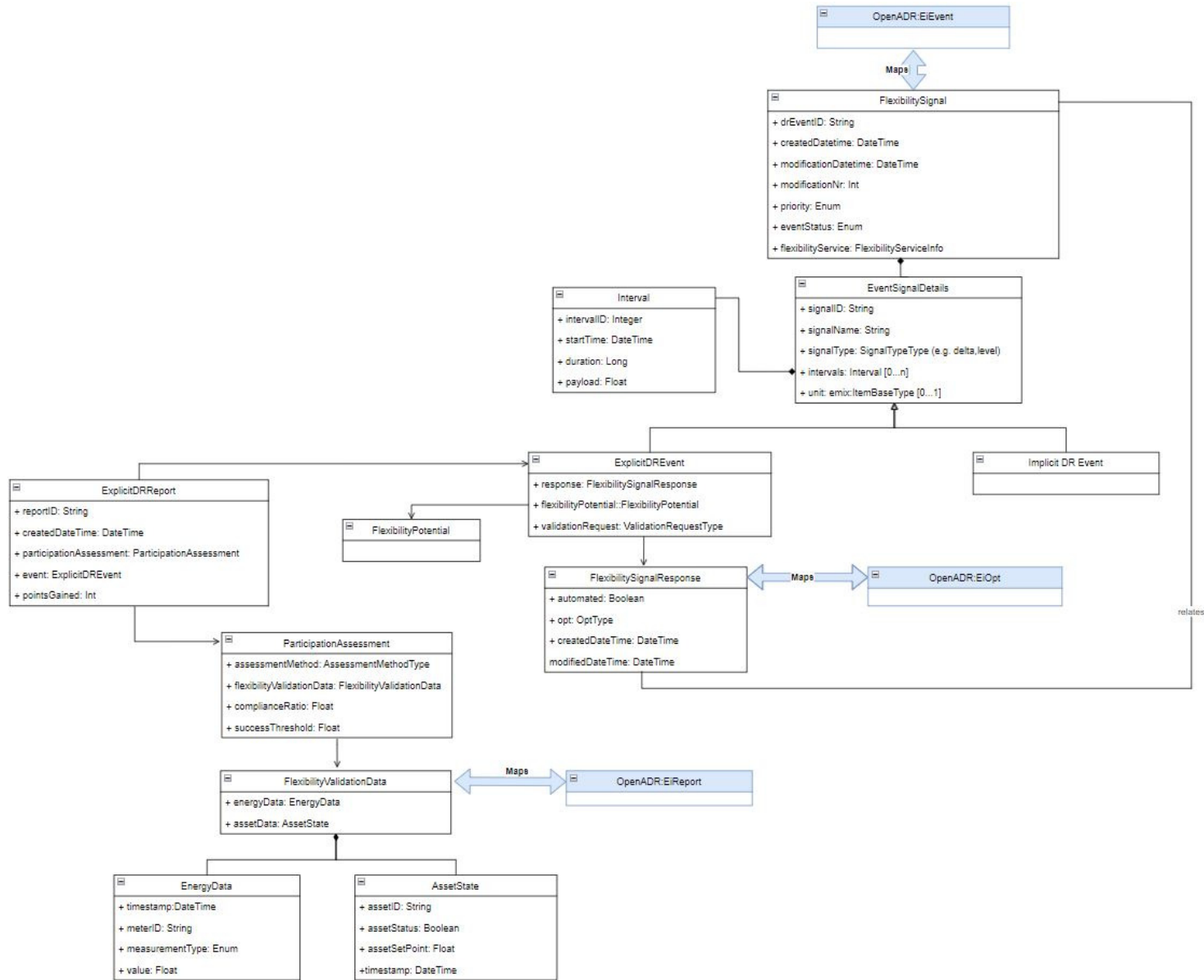

Figure 3: Data models for the A&M Interface Module – Flexibility Signal, Validation Data, and Report.

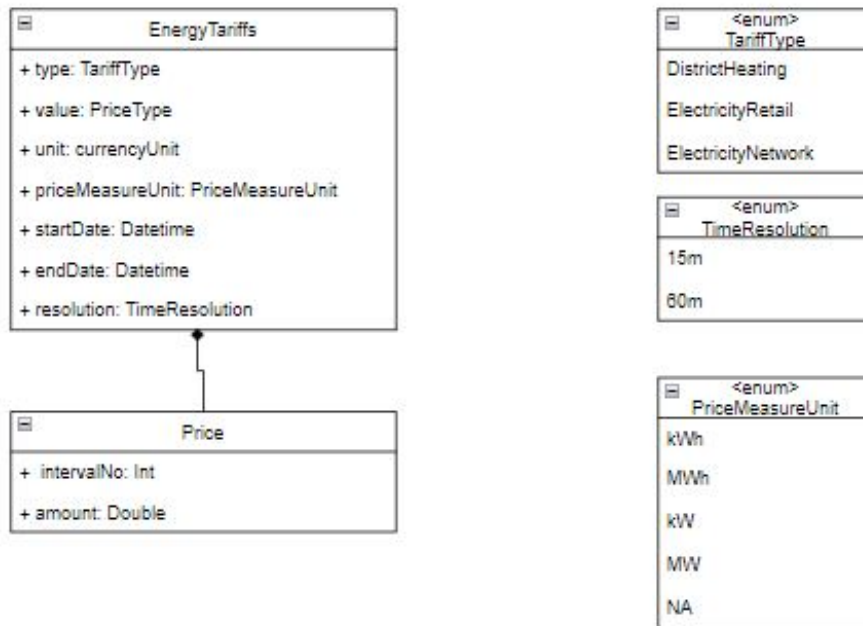

Figure 4: Data models for the A&M Interface Module – Energy tariffs.

3.3.3 Automated Flexibility Manager

The data items of the Automated Flexibility Manager interface are presented in Table 13. The data models are further elaborated in Figure 5.

Table 13: Logical interface of the Automated Flexibility Manager.

Data item	Description
Flexibility Potential	This data item contains a forecast of the baseline and flexibility potential for the customer.
Explicit Flexibility Activation	This interface is used for explicitly activating flexibility of the consumer.
Load Measurement	This interface provides load measurements for estimating how reliable the forecasts are for a given consumer. This information can be used by the aggregator to estimate the uncertainty of the flexibility management.
Flexible Asset Schedule	This data item specifies the schedule for a flexible asset.

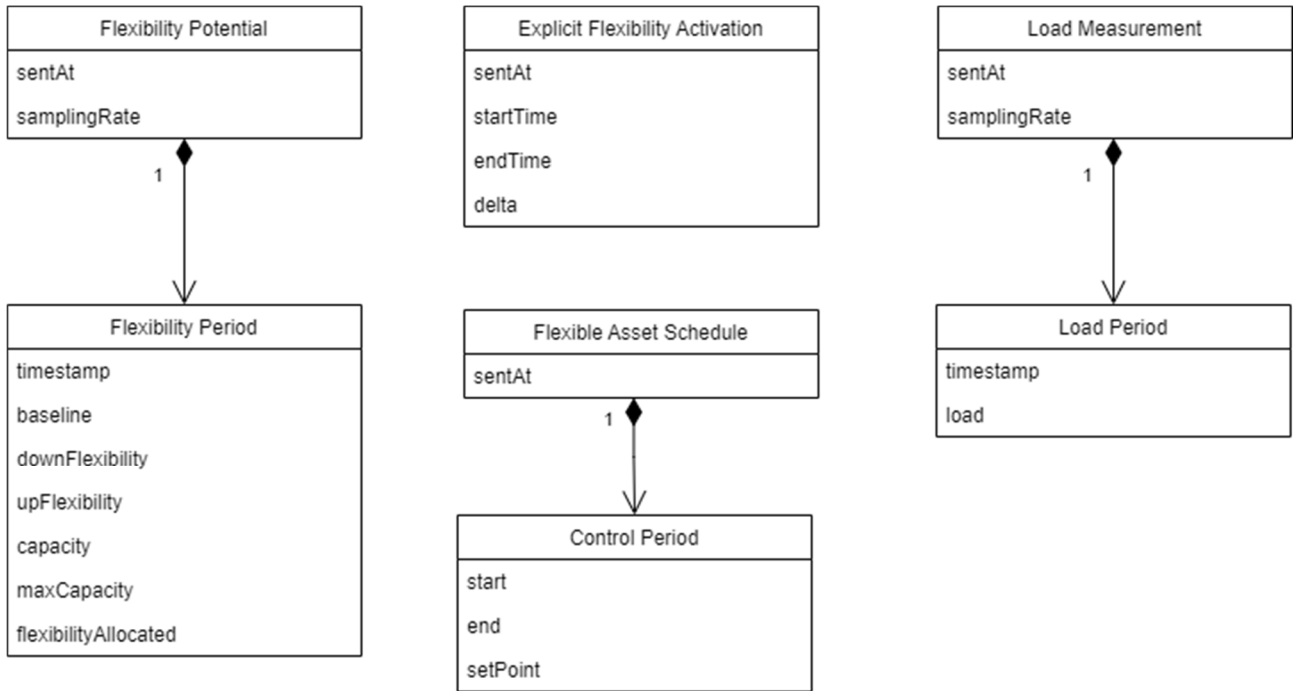

Figure 5: Data models for Automated Flexibility Manager interface.

3.3.4 Digital Twin Repository

The data items passed through the logical interface of the Digital Twin Repository is presented in Table 14. The data models are further elaborated in Figure 6.

Table 14: Logical interface of the Digital Twin Repository.

Data item	Description
Predict request	This data item is used for requesting a prediction from the Digital Twin Repository. The data item specifies the desired load levels for each period. In no load is specified then a baseline load is assumed.
Prediction Response	Specifies the predicted response of the consumer in the given situation.

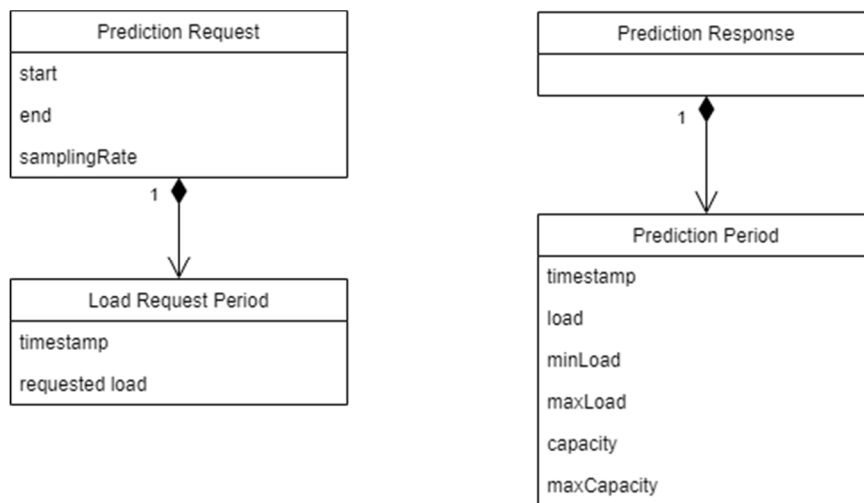

Figure 6: Data models for Digital Twin Repository interface.

3.3.5 End-user Interface

The data objects, which are relevant to the User Interface Module are presented in Table 15, while the respective data models and their relationships are presented in Figure 7 and Figure 8.

Table 15: Data objects relevant to the UI Module

Data item	Description
Flexibility Signal	This data object describes the information concerning a DR event, which is presented to the iFA end user via the UI.
User Acceptance	This data item models the response of an end user to either external (e.g. DR events) or internal to iFA (e.g. proposed schedules) suggestions.
Event Acceptance	This data item further elaborates User Acceptance in the case of DR events.
iFA Suggestion Acceptance	This class further elaborates User Acceptance in the case of iFA-generated suggestions.
iFLEX Suggestion	This data item models the suggestions generated by iFA.
Asset Suggestion	This data object further elaborates an iFLEX Suggestion, containing information at asset level.
Notification	Describes the various notifications presented to the iFA end user.
User Preferences	This data item models the various preferences of an end user of the iFA (e.g. objectives, mute notifications, preferred schedules).
Objective	Elaborates the user preferences with respect to optimisation objectives.
Temporary Silence	This data item describes the parameters related to temporarily muting notifications.
Silence Rule	This data item defines the parameters relevant to setting recurrent periods, during which notifications are muted.
User Schedule Preference	This data object models the user preferences with respect to schedules.
User Asset Schedule Preference	This data item further elaborates the preferred schedules of the iFA end user at asset level.

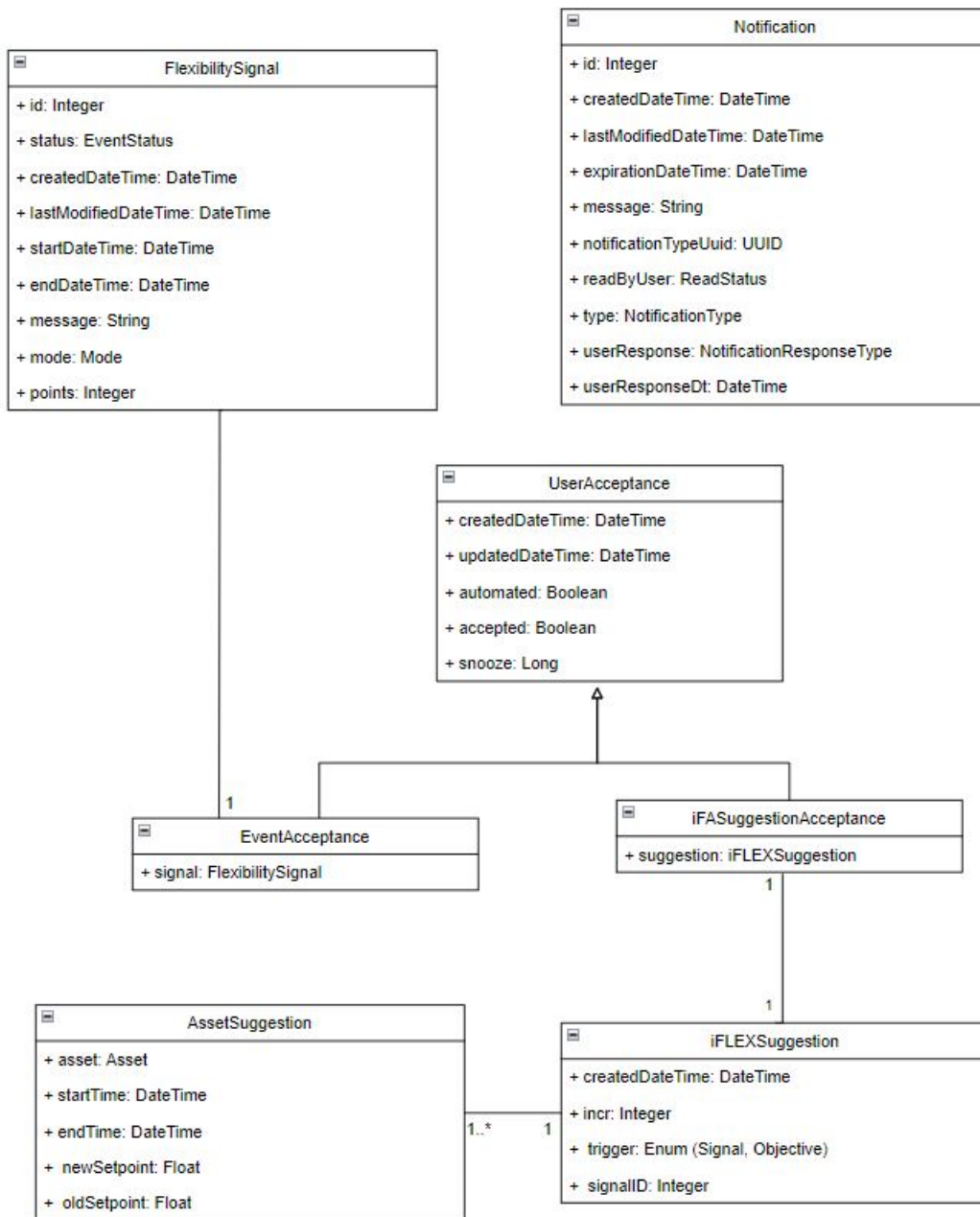

Figure 7: Data models for the UI Module – iFLEX Suggestions and User Acceptance.

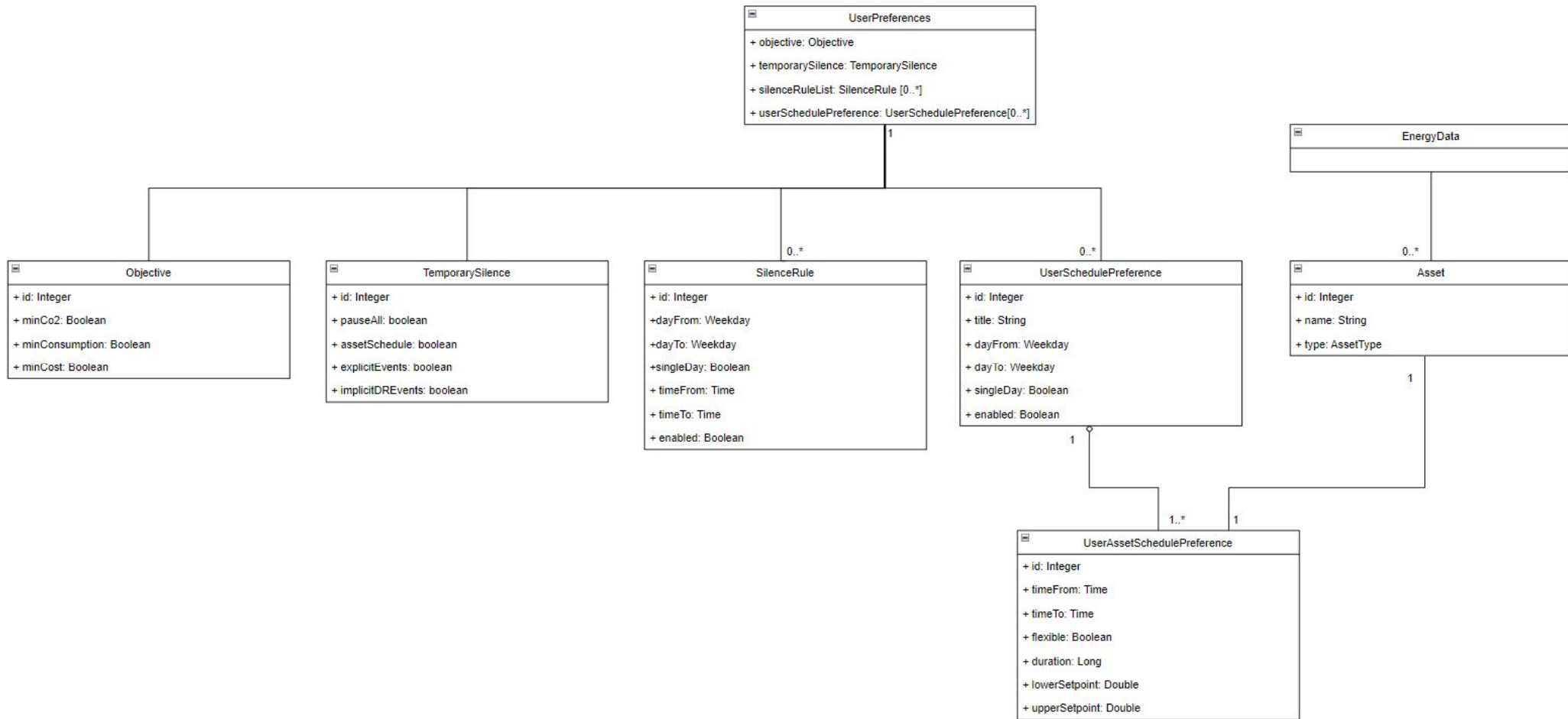

Figure 8: Data models for the UI Module – Preferences and configurations.

3.3.6 Resource Abstraction Interface

The data items used in the RAI interface are collected in Table 16 and presented in graphical form in Figure 9. The items are used to describe a state of a household but can be easily reused, entirely or in parts, for representing other data environments, for example a building or weather data.

Table 16: Logical interface of the RAI model

Data item	Description
Household	A household is represented by an id, name and list of devices
Device	The device is specified by id, type and name. The device has its state, control capabilities and a list of sensors.
Sensor	A sensor is described by sensor id, name, type and list of sensor measurements.
Sensor measurement	A sensor measurement is described as specified in Sensor Measurement Lists (SenML) RFC 8428 (Jennings et al., 2018). The measurement is specified by version, name, unit, time and value.
Device Capability	Device capability is specified by control type and control commands.
Device State	Device state is specified by state type and state value. Both the device capability and device state designs are influenced by SAREF4ENER specification (Daniele, 2020).

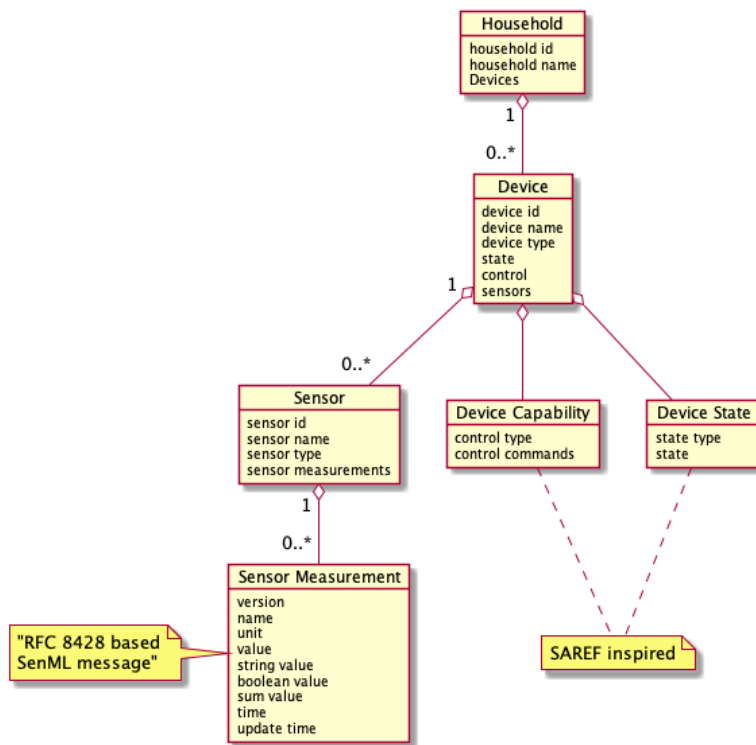

Figure 9: RAI Household information view.

3.3.7 Weather Service Interface

The weather service data describes weather data collected or predicted for a certain geographic location. The data from sensors for the location is described in same manner as other sensor measurements data in SenML format.

Table 17: Weather Service information view

Data item	Description
-----------	-------------

Weather location	A weather location is described by location name, geolocation and a list of weather sensors.
Geolocation	Geolocation is described by latitude and longitude.
Sensor	A sensor is described by sensor id, name, type and list of sensor measurements. Sensor type denotes type of the weather data, either forecast or realisation.
Sensor measurement	A sensor measurement is described as is specified in Sensor Measurement Lists (SenML) RFC 8428 (Jennings et al., 2018). The measurement is specified by version, name, unit, time and value.

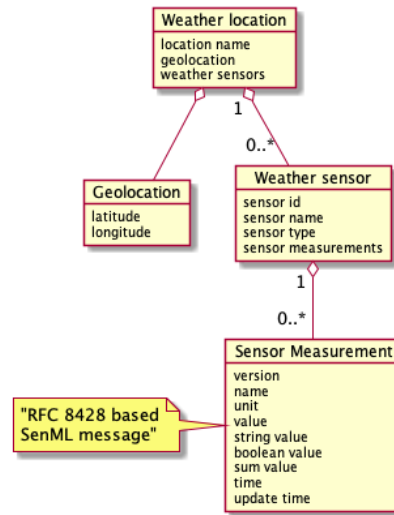

Figure 10: Weather Service information view.

3.3.8 Trust, Security and Privacy Interface

The data classes, which are used to provide trust, communication security and privacy are presented in Table 18. Graphical representation is shown in Figure 11 and Figure 12.

Table 18: Information data items for the Trust, Security and Privacy Interface

Data item	Description
Digital Identity Document	Composed of a Digital Identity and Authentication Information. It contains the necessary information to authenticate and establish a secure connection to the end-user.
Authentication Information	Contains the information about the end-user: his role, type of authentication, who controls the identity and the public key. Authentication Information is further used in authorization process.
Digital Identity	A digital identifier, unique to a specific end-user/resource.
Resource Document	Contains the Resource Identifier and Resource Description. Specifies the information about the specific resource, that the end-user might want to access/control.
Resource Description	Contains the description of a specific resource: The location, owner, type and available operation on the resource.
Verifiable Credential	Presents a document which includes claims, proving that the end-user is a part of the iFA pilot. Verifiable credential is issued to the holder by the Issuer (Enrolment Module) in the process of enrolment and contains the date of issuance and expiry.
Claim	A specific claim about the holder of the Verifiable Credential (e.g. holder is a part of the iFA pilot).

Environment of the access control invocation	Contains the necessary data for the control of access and accounting purposes. This composes of current time, authentication information, delegation of access, requested operation on the resource and a request's access policy.
Policy	Contains the specific resource's access control policy, e.g. who is authorized to access/control the resource.

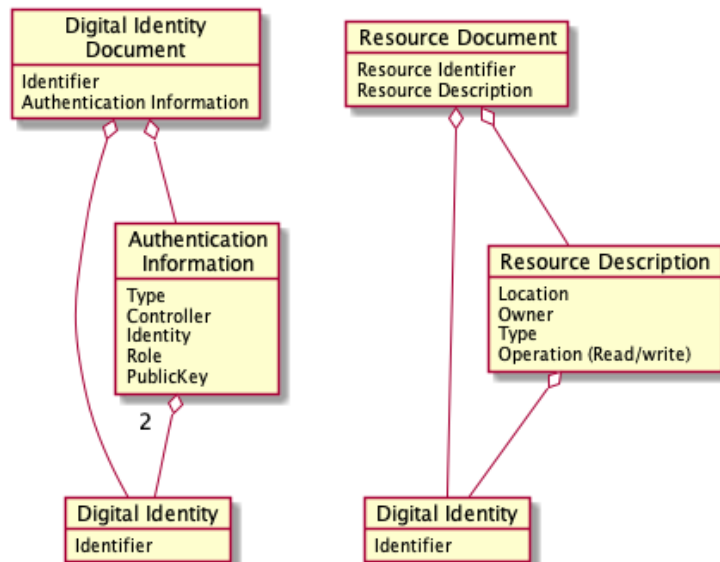

Figure 11: Digital identity and Resource document.

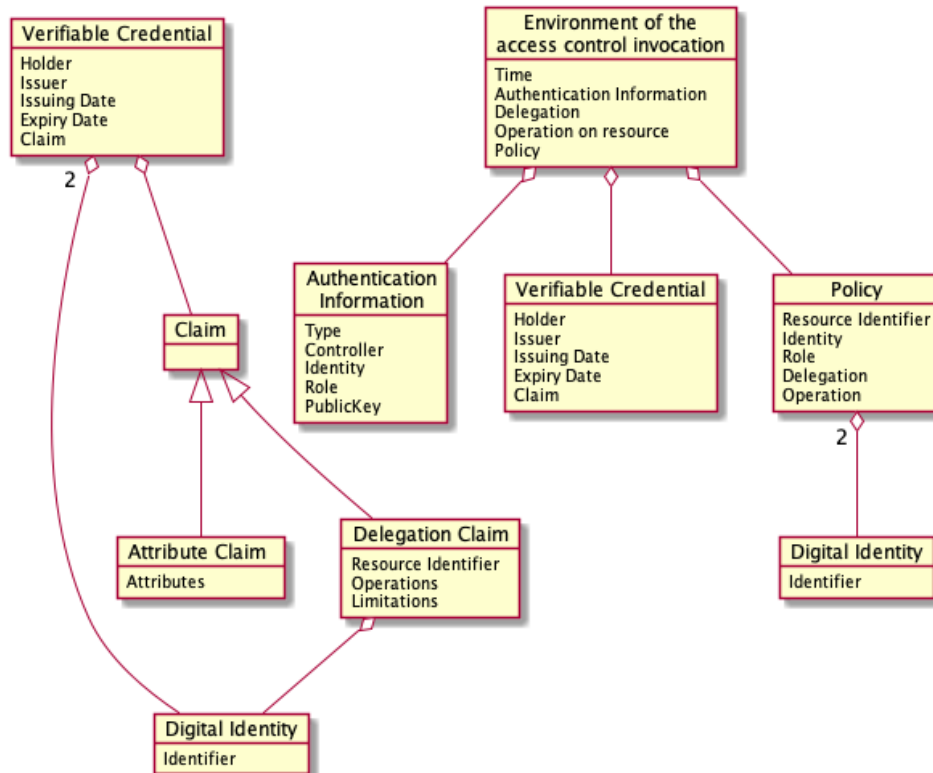

Figure 12: Verifiable credentials and Environment of the access control invocation.

3.4 Interoperability perspective

SGAM (Smart Grid Architecture Model) represents following interoperability dimensions: Business, Function, Information, Communication and Component (see Figure 13).

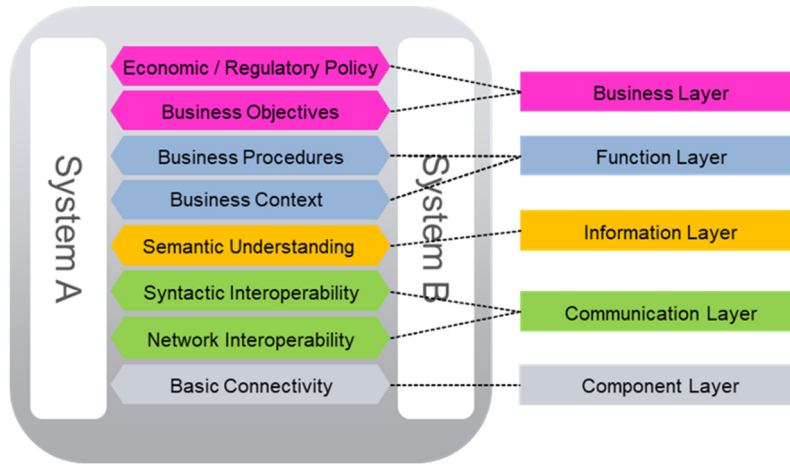

Figure 13: Interoperability dimensions of SGAM (CEN,2012).

The business layer: Regulatory and economic (market) structures and policies, business models, business portfolios (products & services), business capabilities and business processes.

The function layer: Functions and services and their relationships from an architectural viewpoint.

The information layer: The information (i.e., information objects and the underlying canonical data models) that is being used and exchanged between functions, services and components.

The communication layer: The protocols and mechanisms for the interoperable exchange of information between components in the context of the underlying use case, function or service and related information objects or data models.

The component layer: The physical distribution of all participating components (system actors, applications, power system equipment, protection and tele-control devices, network infrastructure, and any kind of computers) in the smart grid context.

The interoperability focus is on Information and Communication layers. The different technologies and standards utilized in the iFLEX Framework with mappings to the corresponding interoperability levels of GridWise Architecture Council (Council, 2008) are summarized in Table 19.

Table 19: Technologies and standards for different interoperability layers.

Technology	Interoperability layer
IEC 62746-10-1 (OpenADR2.0)	Semantic interoperability
SAREF/SAREF4ENER	Semantic interoperability
LonWorks	Semantic interoperability (covers also lower layers)
BACnet	Semantic interoperability (covers also lower layers)
KNX	Semantic interoperability (covers also lower layers)
Z-Wave	Semantic interoperability (covers also lower layers)
ZigBee	Semantic interoperability (covers also lower layers)
M-Bus	Syntactic interoperability (covers also lower layers)
HTTP (REST)	Syntactic interoperability (covers also lower layers). Does not specify the payload syntax.
MQTT	Syntactic interoperability (covers also lower layers). Does not specify the payload syntax.
JSON	Syntactic interoperability
oBIX	Semantic interoperability (covers also lower layers)
FTP	Syntactic interoperability

How the above listed technologies are planned to be used between the iFLEX Framework and external systems, as well as, between functional components of the iFLEX Framework is presented in Figure 14. In some cases, there are several arrows between components represented in the Figure 14. This means that there are several options for realizing the interoperability and the technology choice is always case specific. The term Programming Language Application Programming Interface (PL API) is also listed as an option in several places. This refers to a case where parts of a functional component are imported as a software library and the interoperability is realized within the programming language of choice. This case is typical if the components are deployed into the same software process for practical reasons. It is again case specific when this option is the preferred one. In addition to the machine-to-machine interfaces and standards, some information is fed into the system via User Interfaces (UI). Examples of practical deployment have been presented in D6.5 Initial Application-specific iFA prototypes and will be updated in successive versions (D6.6 and D6.7).

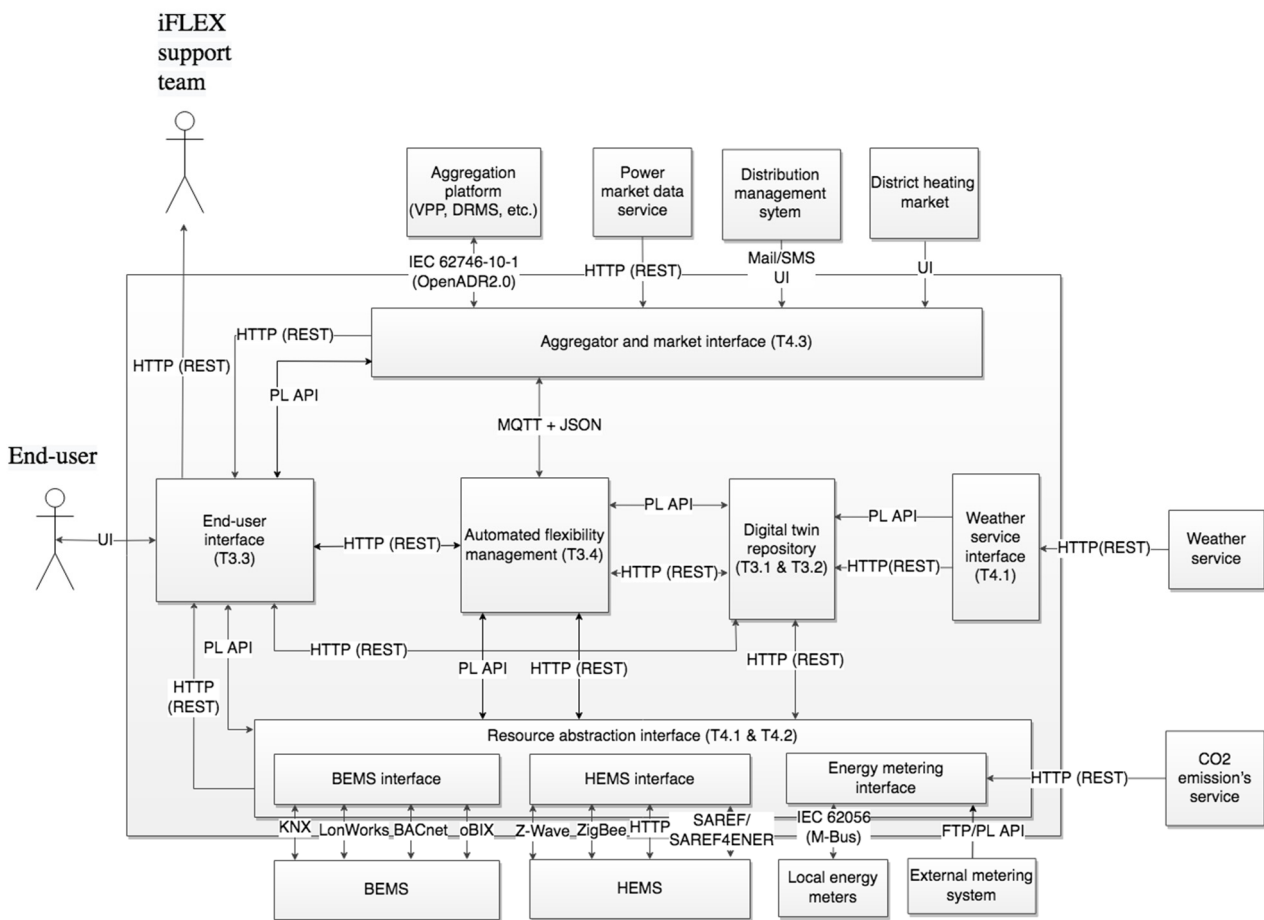

Figure 14: Mapping of the interoperability technologies to the functional architecture of the iFLEX Framework.

3.5 Security and privacy perspective

Smart Grid Coordination Group document on Smart Grid Information Security (SG-CG/M490/H_ Smart Grid Information Security, 2014) rightfully exposes a need to address the security perspective at each layer of the SGAM architecture as presented in Section 3.4. The iFLEX architecture addresses only a small subset of the smart grid architectural model (SGAM) domains and zone plane but all the interoperability layers. The security perspective should therefore address all the layers of the SGAM.

The component layer is represented by BEMS and HEMS components and local or external metering systems, as depicted in Figure 14. The communication layer is represented with a bunch of potential protocols for interconnecting the devices at customer premises with the iFA. To the SGAM communication layers the other iFA protocols could be added, denoted in the figure with HTTP (REST), PL API and MQTT. The iFLEX architecture can only reuse any security features provided by the denoted protocols and make sure that the

protocols' security features are implemented and used properly on iFA's side. In the project deliverable D2.1 the requirements related to the component layer and communication layer were denoted with the requirement SEC-06-ECOSYS and SEC-03-COMSEC. The iFA protocols will be used as means to implement necessary information exchange to fulfil D2.1 requirement SEC-02-AAA. The information layer covers the data models and related data. The D2.1 requirements related to the data are SEC-04-CIA covering confidentiality, integrity and availability of the data and SEC-05-REST, addressing security of the data at rest. The requirement SEC-02-AAA partly covers confidentiality requirements related to the information layer. The functional layer covers functions and services to the end user, aggregator and iFLEX support team. The security of these functions and interfaces is covered again with the requirement SEC-02-AAA. The system needs to fulfil the requirement SEC-01-TRUST so the entities in the system could recognize and relate each other to foreseen roles in the system. The iFLEX architecture does not expose particular business layer functions per se, the business use cases as presented in D2.1, build upon the functional layer.

Privacy has been a real concern noted in Smart Grid Information Security (SGIS) document (SG-CG/M490/H_Smart Grid Information Security, 2014). The privacy requirements exposed in the deliverable D2.1, from PRI-01-CONSENT to PRI-07-RTBF, cover all the major concerns denoted in the SGIS document. Both the security and privacy requirements will be further developed and expanded in forthcoming deliverables D4.8 and D4.9 on Secure consumer data management module.

4 Architectures for domain specific iFLEX Assistants

This section represents two different applications of iFLEX Assistants; one for households and one for a building community.

4.1 Architecture of an iFLEX Assistant for households

This section introduces a system architecture for an individual residential building iFA designed for the Slovenian and Greek pilot. The iFA for a building is associated to the following Business Use Cases and High Level Use Case:

- BUC-3: Offer the flexibility of a multi-vector energy system (building community) to the energy markets.
- BUC-4 - Optimal energy consumption for multi-vector energy system (building community) based on the behaviour of consumers and market price signals.
- BUC-6: Increase self-balancing through advanced monitoring and automation
- BUC-7: Optimise end-user’s energy consumption based on own preferences and market price signals
- HLUC-1: Manage energy of the premises in an optimal way.
- HLUC-2: Manage flexibility requests or price signals at individual premise level.

4.1.1 Context view

Figure 15 illustrates the context view of the iFA to be developed for the households in the second phase of the project.

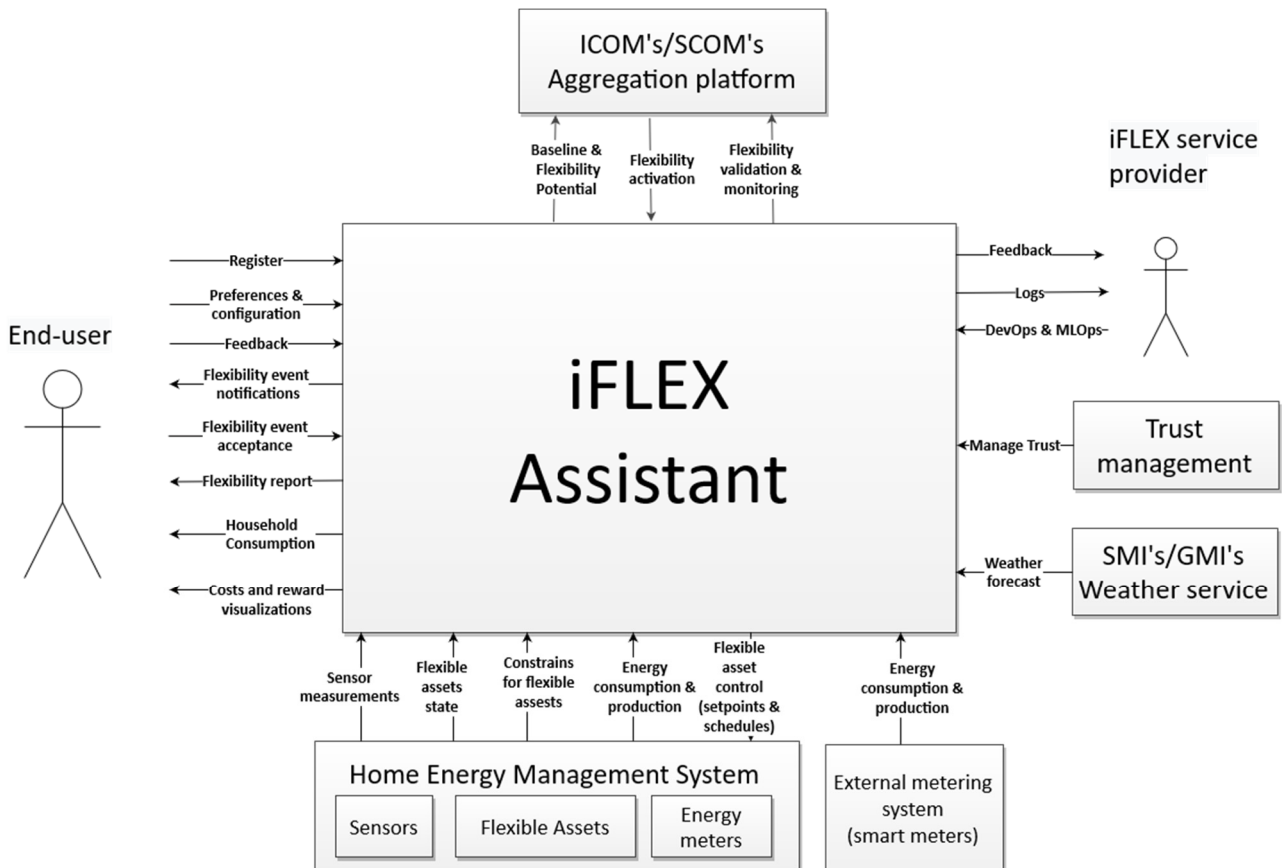

Figure 15: Context view of the iFLEX Assistant to be customized for the household (SI and GR pilots).

The iFA for phase 2 provides the following functionalities to the end user:

- Registration, preferences, and configurations are used for initialising end-user profile and configuring the iFA according to user's desires
- User's participation in (scheduled) flexibility events is facilitated with event notifications, user's event acceptance and flexibility report
- iFA also serves users with information and/or visualisations on energy consumption at the household and flexible asset level, as well as costs and (flexibility related) rewards
- User's feedback is utilised by the iFlex technical team to further improve the iFA.

The main extensions to the first phase architecture are the full integration of the ICOM's and SCOM's Aggregation Platforms as well as the Home Energy Management System with the iFLEX Assistant. Other important external systems for the iFA include Weather Service provided by Slovenian and Greek Meteorological Institute (SMI/GMI), DSO operated smart metering system for ingesting the household level energy consumption into the iFA, and trust management for user identity and credential handling to facilitate secure consumer data management by the iFA.

4.1.2 Functional view

4.1.2.1 PUC-1 Manage my preferences

PUC-1 concerns the configuration of iFA end user's preferences, including definition of comfort levels and optimisation policy, as well as personalisation of communication.

Scenario: Set schedules of assets

The iFA end users can set schedules for their flexible assets and activate or deactivate them depending on their will. More specifically, upon accessing the schedule menu of the iFLEX app, the user can add a new schedule and set its periodicity. Then, the user can select an asset and define the temporal and operational constraints for its operation. Furthermore, grouping more than one asset under the same schedule is possible, so that the user can define multiple preferences at once. Once the user activates or deactivates a schedule, this information is communicated to the AFM Module, so that it takes into account the activated schedules while devising the optimal schedules of assets. Figure 16 represents a sequence diagram of the interactions between the functional components in Set schedules of assets scenario.

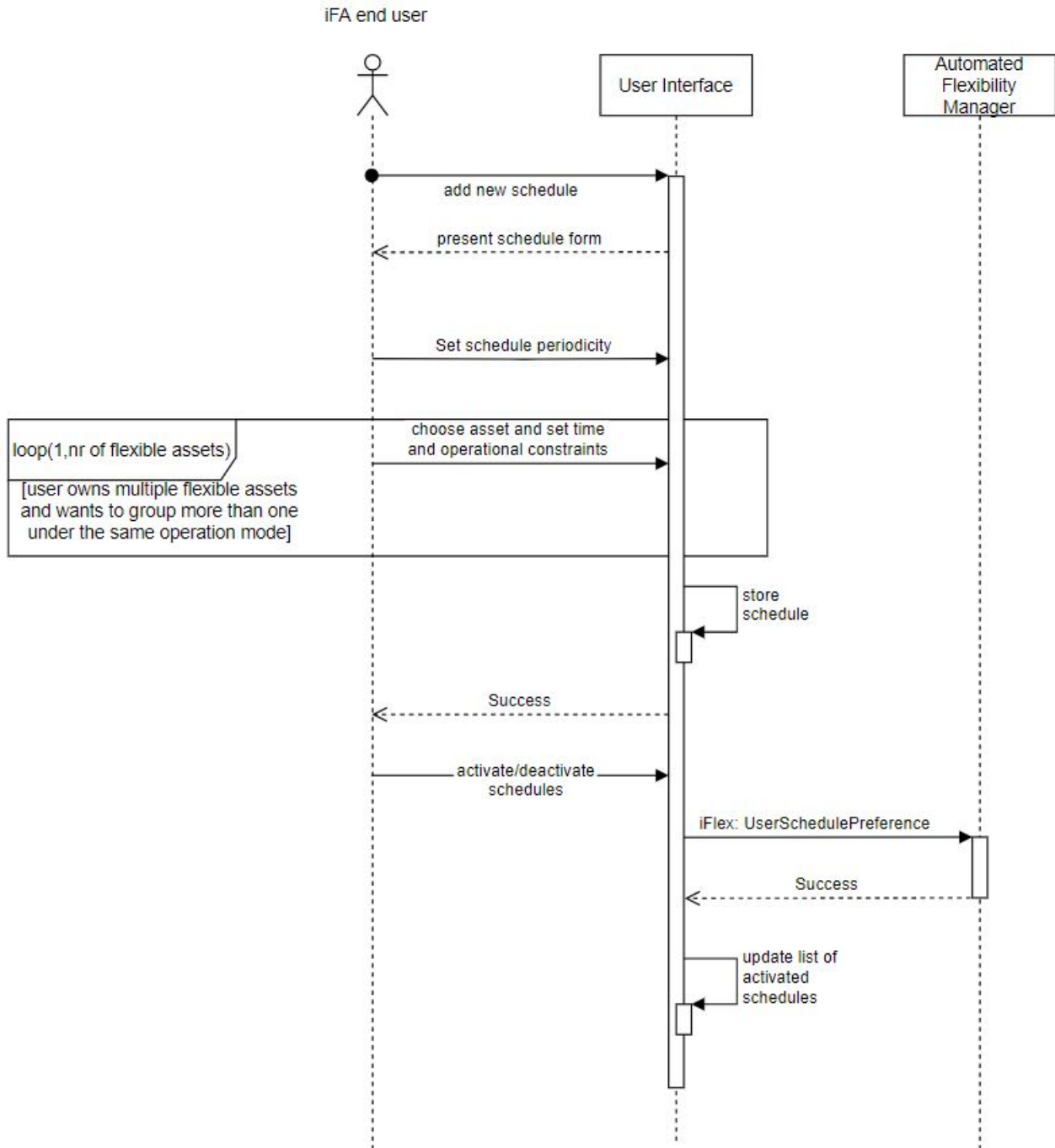

Figure 16: PUC-1 sequence diagram, scenario: Set schedules of assets.

Scenario: Set flexible schedules of assets

The difference between this scenario and the previous one is that the user opts for making a schedule flexible. In that case, the duration of an asset’s operation is set, but the start- and subsequently end-time may vary within certain user-defined limits. Moreover, the user may also set a range for the setpoint of an asset’s operation (e.g. operate a heat pump between 20°C and 21°C). Figure 17 represents the interactions of the scenario.

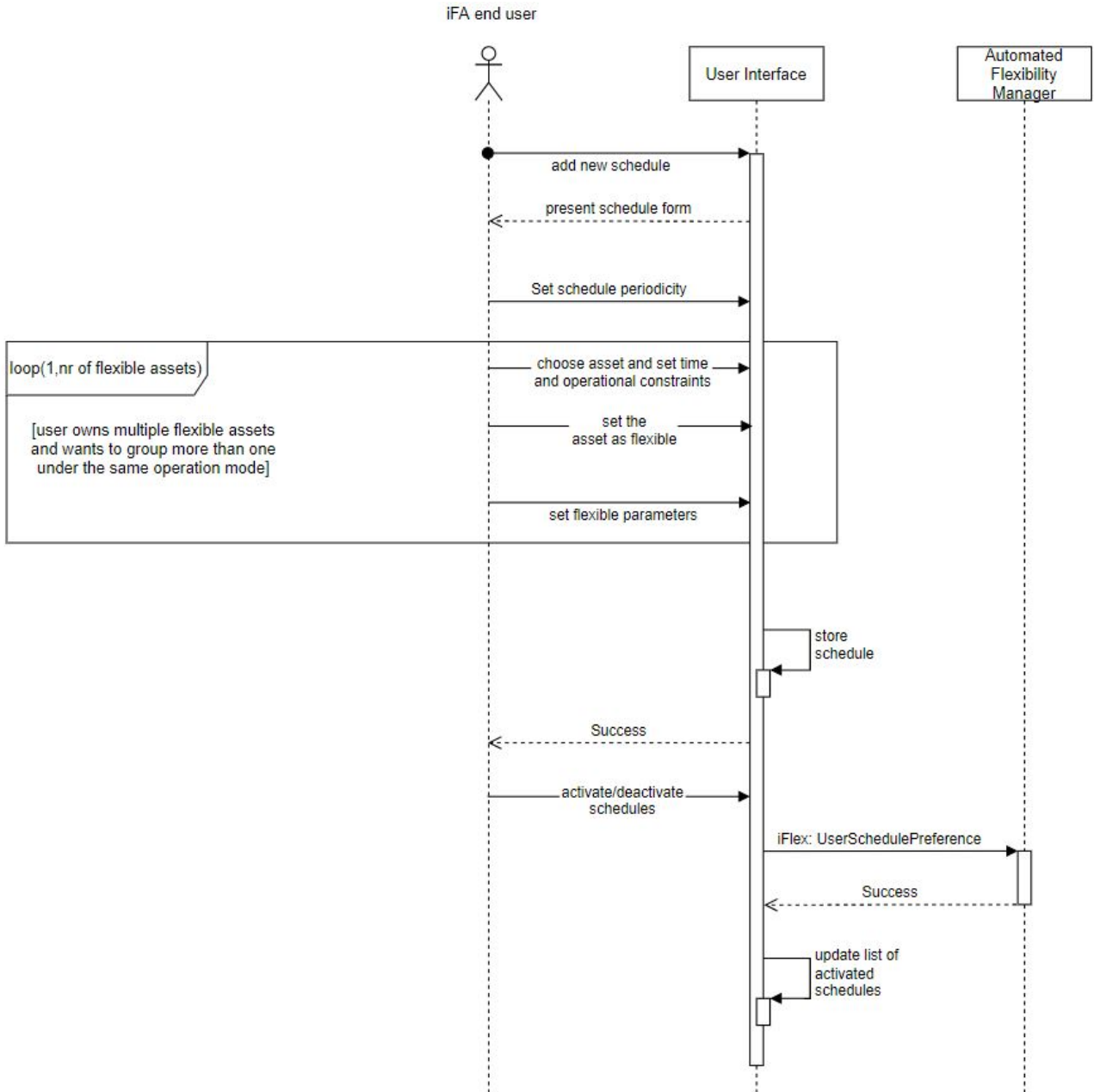

Figure 17: PUC-1 sequence diagram, scenario: Set flexible schedules of assets.

Scenario: Define optimisation policy

The iFA end users can select their optimisation objectives. Upon accessing the optimisation objectives menu, the user can activate and deactivate the available objectives (e.g. cost minimisation, CO₂ minimisation, self-consumption maximisation) depending on their will. Then, the selected objectives are communicated from the UI to the AFM Module, so that it takes them into account while devising the optimal schedules of flexible assets. Figure 18 describes the interactions of the scenario.

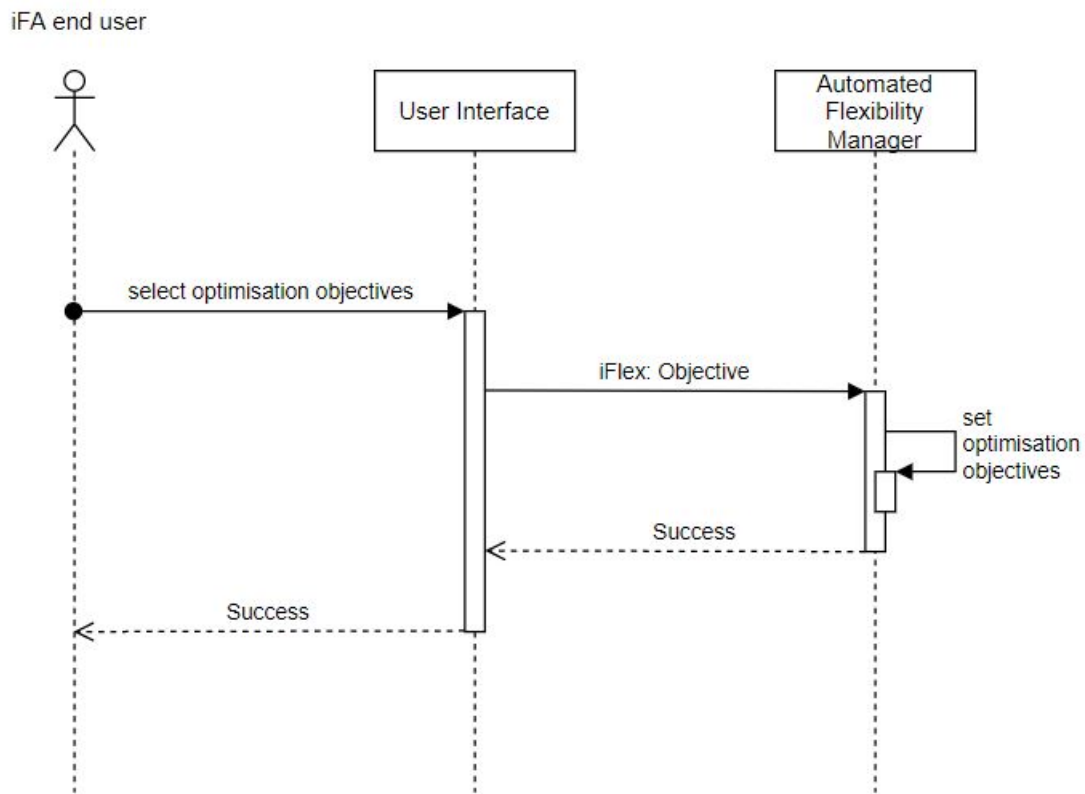

Figure 18: PUC-1 sequence diagram, scenario: Define optimisation policy.

Scenario: Temporarily mute notifications

The iFA end users can set temporary time periods, during which, notifications won't be communicated to them. Upon accessing the notifications menu, users can pause either all notifications or certain types of them for their desired time period. Subsequently, their preferences are saved in the UI Module. Once the chosen time period ends, communication of notifications is resumed. The interactions of the scenario are described in Figure 19.

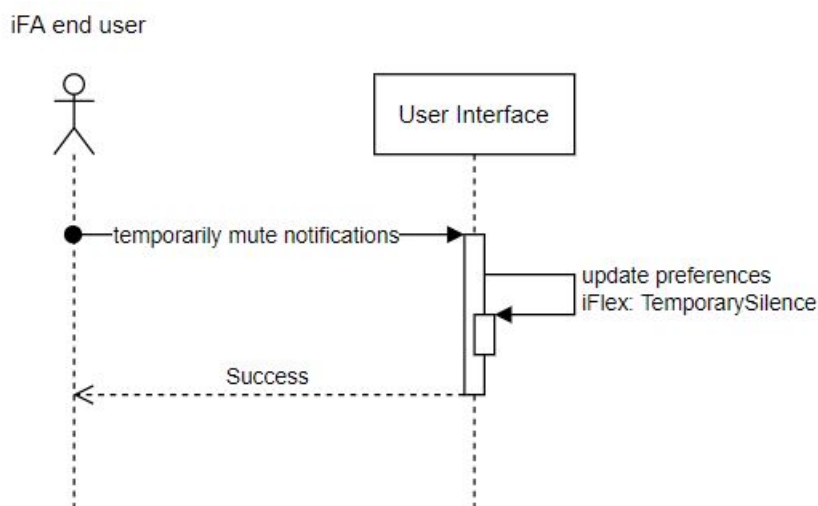

Figure 19: PUC-1 sequence diagram, scenario: Temporarily mute notifications.

Scenario: Mute notifications in recurrent time periods

In addition to the previous scenario, the iFA end users can set recurrent time periods, during which, notifications won't be communicated to them. Users can also enable or disable these "silence rules" in the

iFLEX application, without permanently deleting them, based on their will. Each time their preferences are updated, they are saved in the UI Module. Figure 20 represents a sequence diagram of the interactions of the scenario.

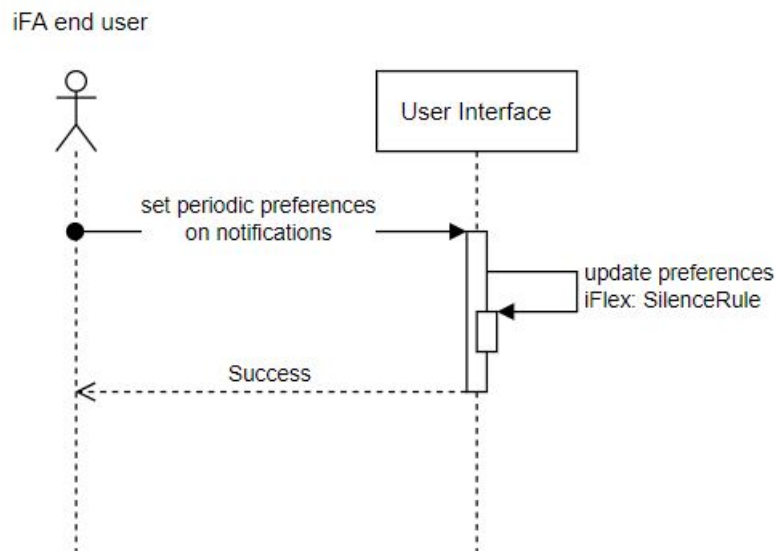

Figure 20: PUC-1 sequence diagram, scenario: Mute notifications in recurrent time periods.

4.1.2.2 PUC-4 View reports for participation or engagement

PUC-4 concerns various reporting services of the iFA. More specifically, iFA informs its users about the benefits that they gain in exchange for participating in DR events. Furthermore, iFA provides the users with an estimation of their energy costs. Finally, users can view the benefits due to the operation of the iFA, on the basis of their preferences.

Scenario: Present DR benefits

The iFA end users can view the benefits that they gained from their participation in a specific DR event, as well as the cumulative benefits for their all-time DR participation. Each time the users participate in an explicit DR event, a flexibility report on their performance is generated by the external Aggregation Platform, which is sent to the A&M Interface Module of the iFA. Then, the report is forwarded to the UI Module. Subsequently, the UI Module stores the report, retrieves relevant information and visualises it, and finally updates the cumulative benefits for the users' all-time participation in DR events. Hence, users can transparently view the benefits both for specific DR events and for their DR performance since they have started participating in the pilot. The interactions of the scenario are described in Figure 21.

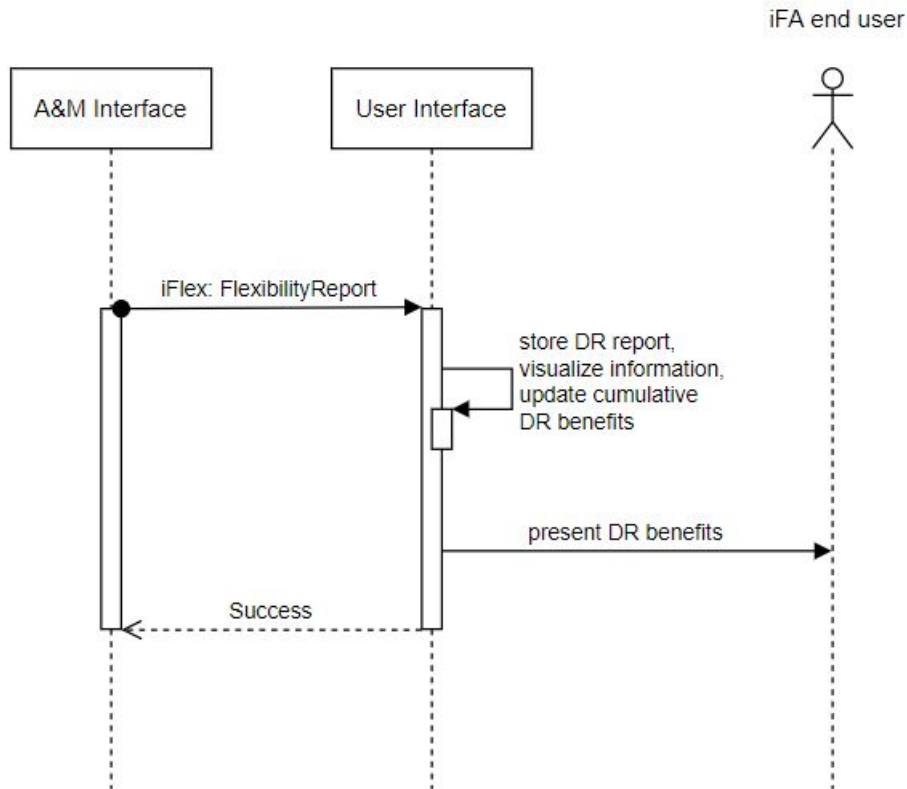

Figure 21: PUC-4 sequence diagram, scenario: Present DR benefits.

Scenario: Estimate energy costs

The iFA end users can view an estimation of their energy costs for the upcoming period. Upon accessing the energy costs menu, the users can ask the iFA for an estimation of their energy costs for predefined periods. Then, the UI Module submits a request to the DTR in order to obtain its energy forecasts for the chosen time period. Subsequently, the energy costs are estimated on the basis of the provided energy forecasts. Finally, the estimation is presented to the iFA end user. The scenario is described in Figure 22.

It is noted that this feature will be available only for predefined periods (e.g. a week, a month, etc.). Furthermore, only an estimation of costs related to energy consumption will be provided. Indirect charges are out of scope. Finally, it is highlighted that this will be just an estimation of energy costs and that the actual costs may differ. Hence, the iFLEX partners cannot be held accountable for any divergences.

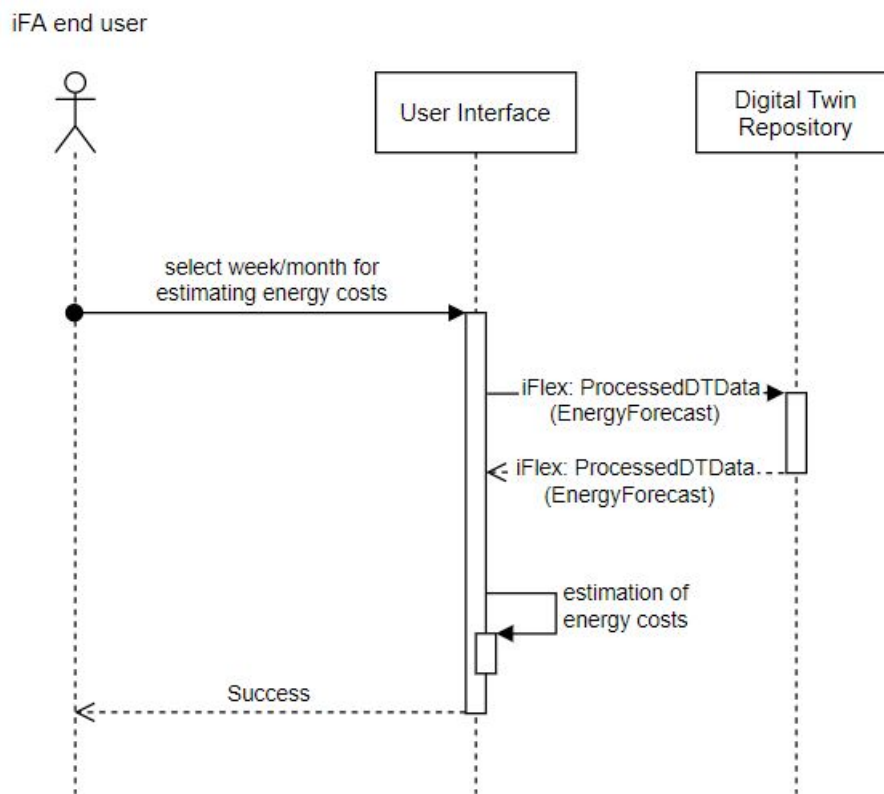

Figure 22: PUC-4 sequence diagram, scenario: Estimate energy costs.

Scenario: Present optimisation benefits

This is an alternative scenario to the next scenario: Present benefits from iFA's operation.

The iFA's objective-based optimisation is a periodic process, which aims at updating the schedules of flexible assets according to the user-defined objectives. Possible objectives can be cost minimisation, CO₂ emission minimisation, and self-consumption maximisation. The calculated optimisation benefits will differ depending on the active optimisation objective(s), so for the previously mentioned objectives the respective benefits can be savings in Euros, savings in CO₂ emissions, and increase in self-consumed energy in kWh.

During the objective-based optimisation procedure, the AFM Module devises an iFLEX suggestion, which is subsequently submitted to the end user for approval – in case of manual operation. If the suggestion is accepted, the AFM Module calculates the benefits from adopting the suggestion compared to the old schedule³. Then, the iFLEX suggestion and the calculated benefits are sent to the UI Module, which updates the cumulative optimisation benefits. Hence, the iFA end users can view the benefits gained from iFLEX schedule suggestions, which were triggered by their selected optimisation objectives, as well as the cumulative benefits due to their selected optimisation objectives. These benefits are presented to the users either on-demand via the relevant page of the iFLEX application or via periodic push notifications (e.g. once per month), which lead to the same page. Figure 23 represents a sequence diagram of the interactions of the scenario.

³ This process becomes clearer by inspecting the iFLEX Suggestion and Asset Suggestion classes in Section 3.2.2.4 (Information view: End-user Interface).

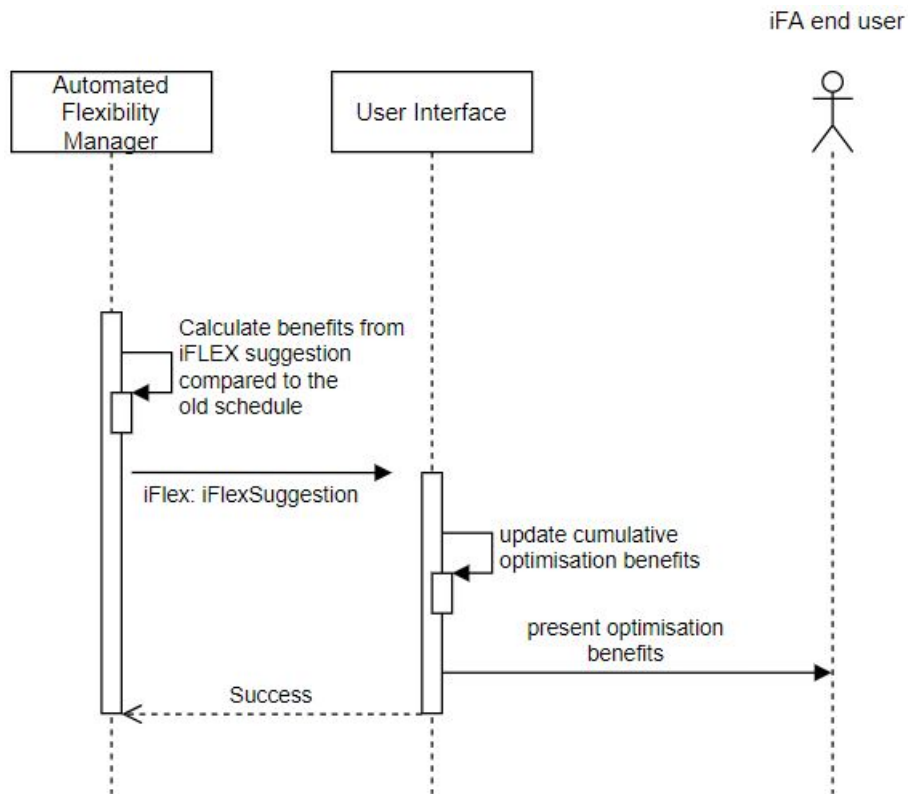

Figure 23: PUC-4 sequence diagram, scenario: Present optimisation benefits.

Scenario: Present benefits from iFA's operation

This is an alternative scenario to the previous scenario: Present optimisation benefits.

The iFA end users can view the benefits from adopting iFA's suggestions compared to their baseline. Upon calculating the user's baseline, the DTR Module also computes the benefits from adopting the iFA's suggestions compared to this baseline. This information is then sent to the UI Module, which updates the cumulative benefits from iFA's operation, so that the user can view them. These benefits are presented to the users either on-demand via the relevant page of the iFLEX application or via periodic push notifications (e.g. once per month), which lead to the same page. The interactions of the scenario is described in Figure 24

It is noted that this method can be applied for a limited period of time, because if the iFA end user adopts the iFA's suggestions, its baseline will gradually be altered accordingly. Hence, no benefits compared to the baseline could be calculated from this point forward.

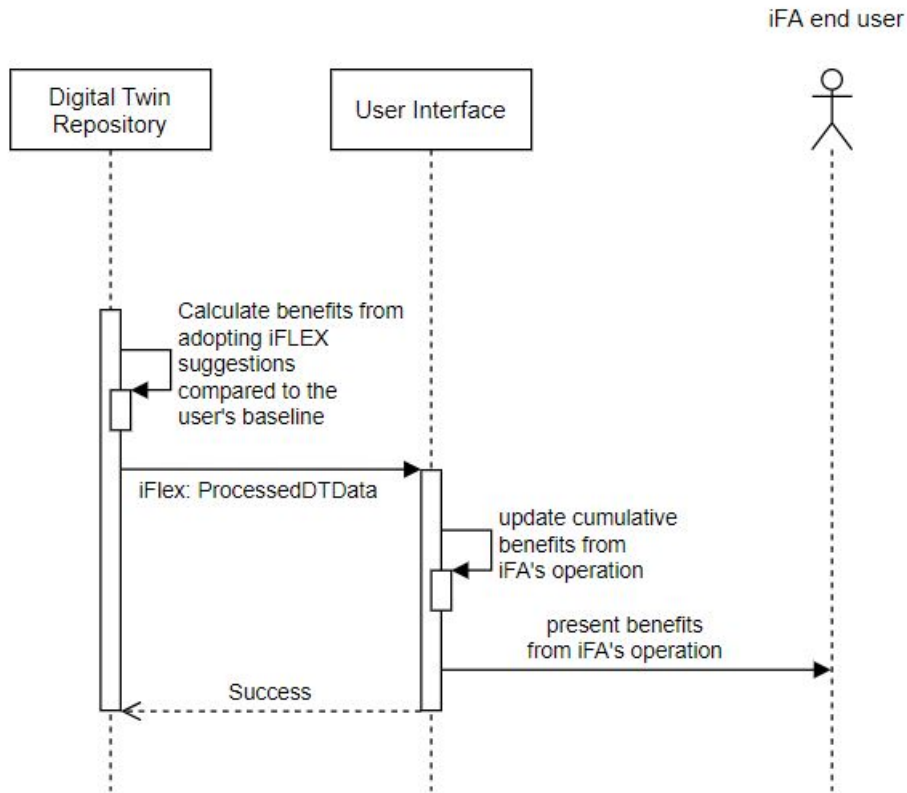

Figure 24: PUC-4 sequence diagram, scenario: Present benefits from iFA's operation.

Two additional use cases; one on flexibility validation data and one on the Greek pilot are described in Appendix A.

4.1.2.3 PUC-7 Monitor my energy in real time

The monitoring of the household consumption is performed close to real time as it is presented in Figure 25. The HEMS continuously pushes the data in real time towards the Resource Abstraction Interface (RAI) where the data is stored and aggregated. Aggregates are prepared for a set of time intervals of 1 minute, 15 minutes, 60 minutes, 6 and 24 hours. Aggregates are prepared per minute interval.

When the iFA end user accesses the monitoring information through the End-user Interface (EUI) the EUI gets the consumption data in question from the RAI and presents the data in a form suitable for visualisation.

All forms of consumption data follow the same PUC pattern, for example consumption per household device or entire household, consumption data based on smart metering from AMI system etc. It has to be noted that the smart metering data can be monitored only as D-1+ (day minus one plus, more than a day).

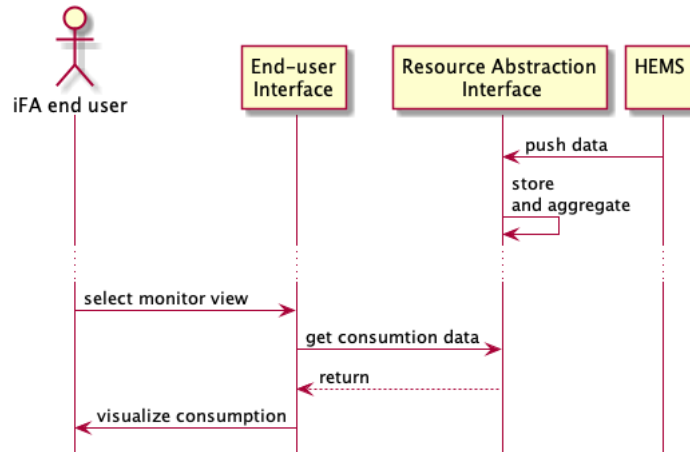

Figure 25: Monitoring of household consumption close to real time

4.1.2.4 PUC-8 Offer flexibility

The interaction between the functional components for PUC-8 is represented in Figure 26. The example focuses on households with schedulable flexible assets such as a water boiler. For set point-based flexible assets such as the heat pump systems in the Slovenian pilot please refer to the section 4.2.2.4.

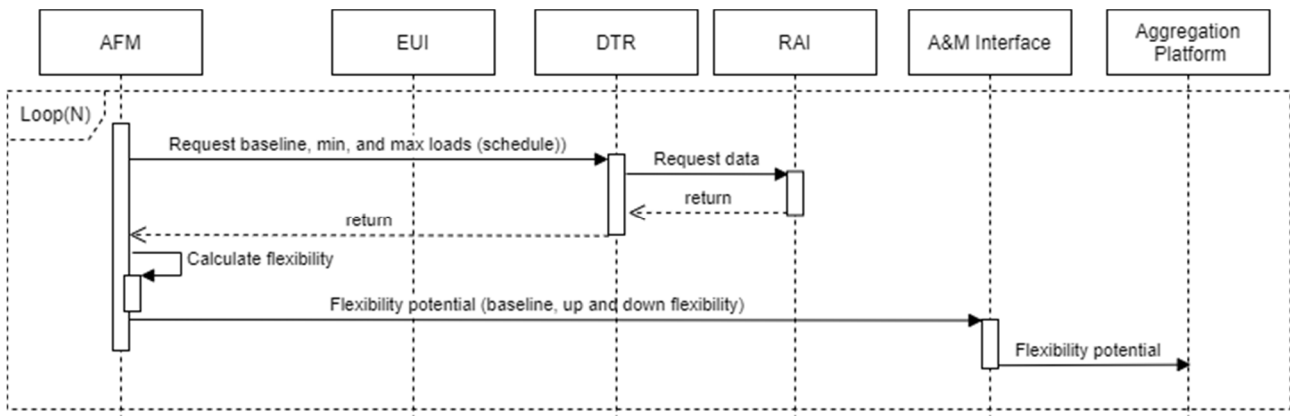

Figure 26: Sequence diagram illustrating the flexibility offering PUC.

The PUC-8 is initiated by the Automated Flexibility Manager that periodically estimates the flexibility potential compared to a baseline consumption. When the time for estimating the flexibility potential occurs, the AFM requests the baseline and flexibility forecast from the Digital Twin Repository module based on the current schedules and user preferences. The depicted scenario assumes that the AFM has the latest data on user preferences which are updated as part of the schedule optimization (see PUC-9 for details). After the AFM has received the predictions from the DTR module it calculates the up and down flexibility for each period. Finally, the flexibility potential signal, including the baseline, and up and down flexibilities are sent to the A&M Interface that forwards the information to the Aggregation Platform.

4.1.2.5 PUC-9 Optimize schedule considering prices and/or incentives

The schedule optimization use case is illustrated with sequence diagrams in Figure 27 - Figure 30. The example focuses on schedulable assets such as the water boiler in the Greek pilot. Please refer to section 4.2.2.5 for HVAC type of flexible asset optimization. The optimization use case can be divided into two main parts planning and control. In the planning part optimal schedules for flexible assets are planned. In the control part the planned schedules are realized by controlling the flexible assets accordingly. The planning phase can be further divided into two types of optimizations: implicit DR and explicit DR.

Figure 27 depicts an example of implicit DR optimization. The scenario is initiated by the AFM that periodically optimized the flexible asset schedule. The implicit optimization takes into account all relevant data affecting the optimization target. In this example, the AFM tries to minimize the costs while complying with the user preferences. The scenario is initiated by fetching the latest energy and network tariffs from the Aggregator & Market Interface component. Then the AFM requests the user preferences (in this example the heating

schedule for a water boiler) from the End-user interface. In this example, a simple simulation-based approach for optimization is illustrated (more advanced optimization strategies are presented in D3.8 Revised Automated flexibility management module). The AFM first generates potential schedules for flexible assets that satisfy the user preferences. Then it requests load profiles for the schedules from the Digital Twin Repository module. Next the AFM calculates the costs for all scenarios and stores the schedule with smallest costs. Finally, the end-user is notified about the new schedule via the End-user interface.

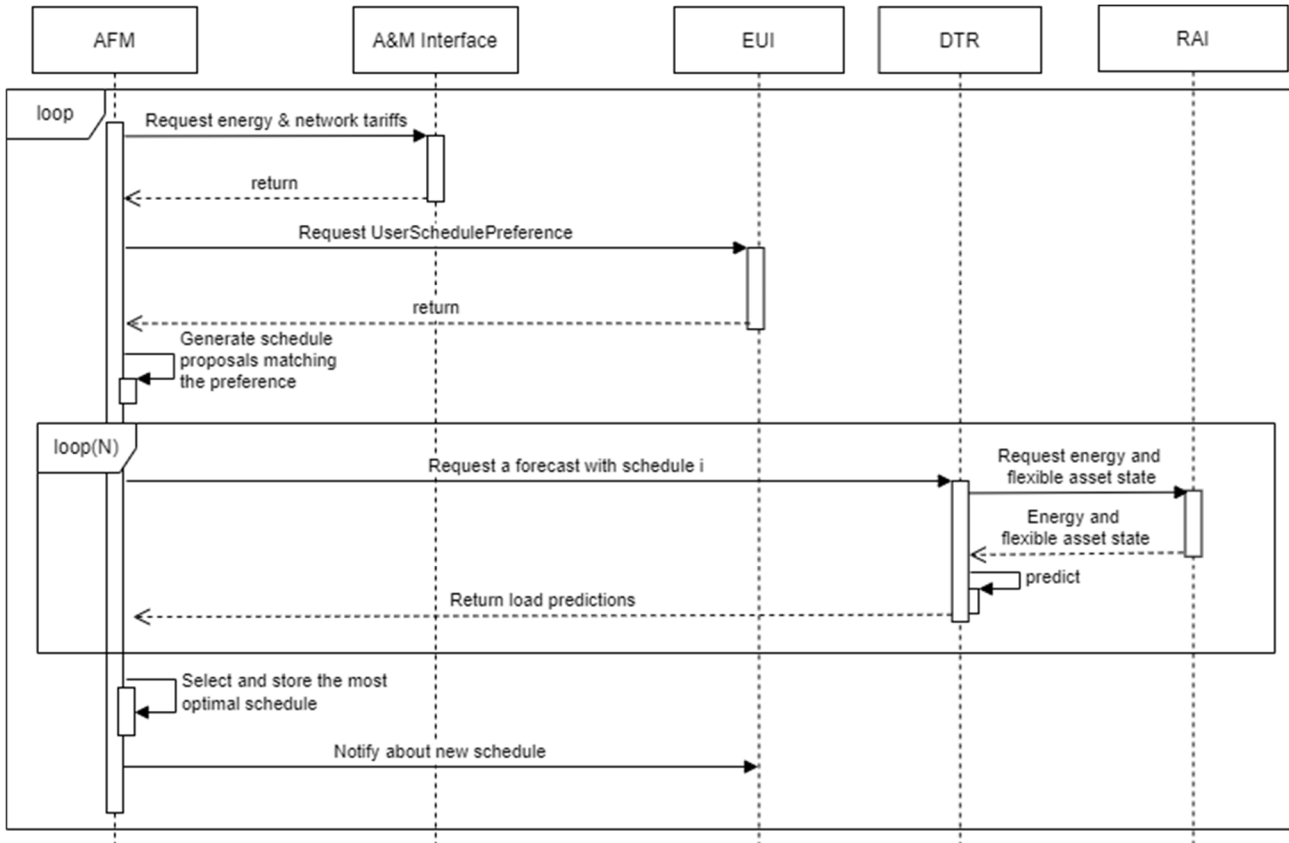

Figure 27: Sequence diagram depicting the implicit DR optimization.

Figure 28 represents interaction of components in the explicit DR optimization (without a need for end-user acceptance for the flexibility signal). The use case is initiated by the Aggregation Platform that sends explicit flexibility activation signal to the A&M Interface that forwards the activation to the AFM. Next the AFM optimizes a new schedule by taking the flexibility activation into account (i.e., the baseline obtained from implicit DR optimization is modified). To this end, it first fetches the user preferences from the End-user Interface. New schedule is then calculated and updated to the EUI. The final step is to evaluate the new baseline, flexibility and calculate the amount of flexibility that is going to be activated as a response to the activation message. This is done by requested the associated baseline and flexibility forecasts from the Digital Twin Repository. Finally, the Aggregation Platform is informed about the flexibility activation, new baseline, and flexibilities.

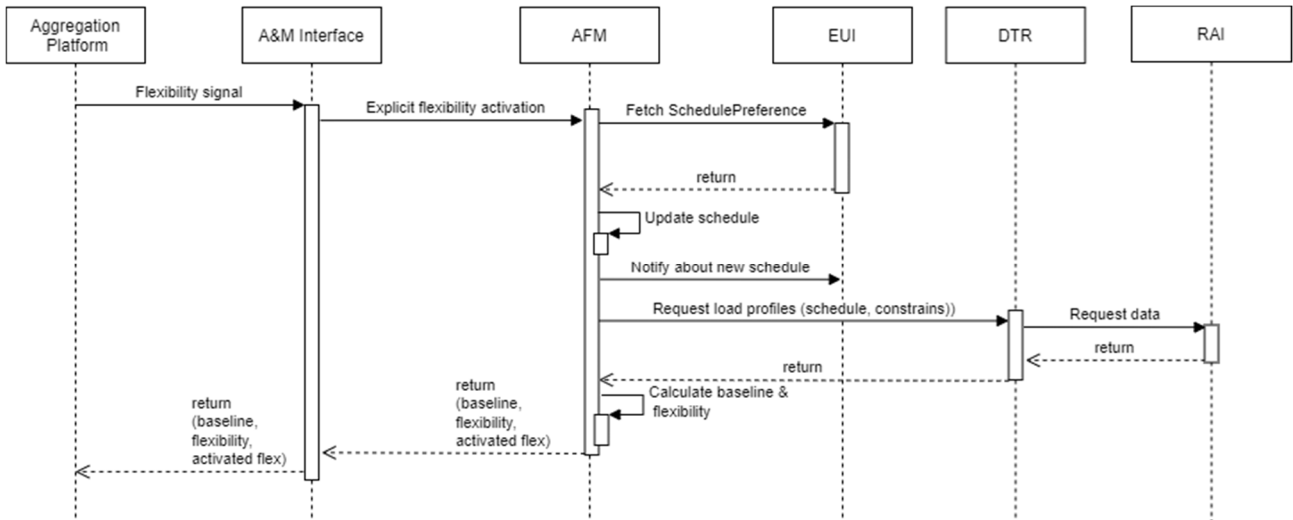

Figure 28: Sequence diagram illustrating explicit DR signal and schedule optimization without a need for explicit acceptance from the End-user.

Figure 29 illustrates the sequence diagram for explicit DR activation with the requirement for user acceptance (i.e., the only difference is that the user needs to approve the flexibility signal). The interaction of components is otherwise identical to the scenario described above except for the additional confirmation from the end-user.

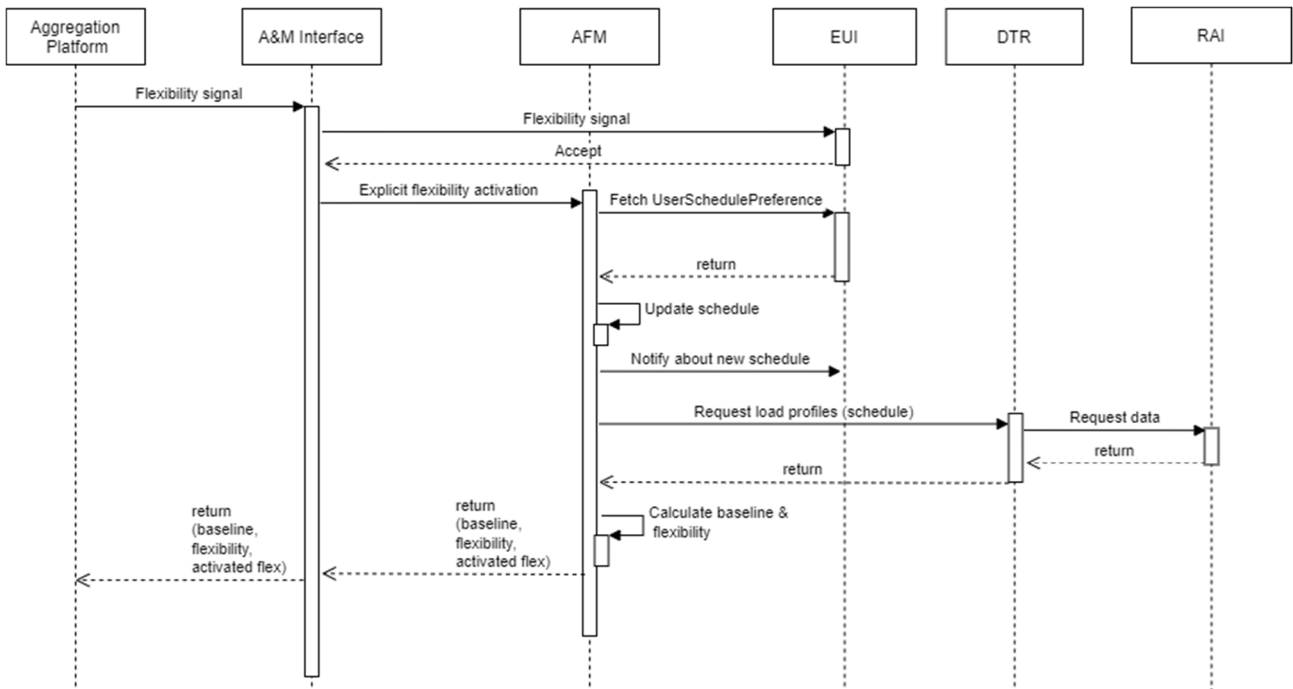

Figure 29: Sequence diagram illustrating explicit DR signal and schedule optimization with explicit acceptance from the End-user.

The control part of the flexibility optimization is represented in Figure 30. The control part is responsible for implementing the schedule in practice by sending the control commands to the RAI at timely manner (according to the schedule).

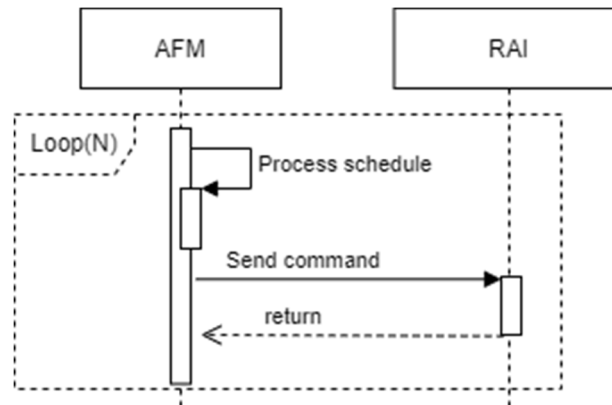

Figure 30: Sequence diagram illustrating the scheduling of flexible assets.

4.1.2.6 PUC-10 Increase self-balancing through forecasting and automation

The PUC-10 use case addresses how to increase self-balancing through forecasting and automation. A sequence diagram of the use case is presented in **Error! Reference source not found.**. The sequence diagram focuses on interaction between actors and system components and system components itself. The use case focuses on multiple goals, for example increasing self-consumption or minimising energy costs in a household with heating equipment and PV generation.

Self-optimisation is controlled by user actions. The user can configure if the control can be automated or needs manual confirmation. Self-optimisation can be turned on or off. When it is turned on the self-optimisation loop starts as is presented in **Error! Reference source not found.**. The Automated Flexibility Module (AFM) starts the optimisation process either immediately or at new cycle start.

At start of each cycle the user preferences are checked regarding schedules, limits and self-optimisation goals. The AFM requests predictions for the next period from a Digital Twin Repository (DTR). The DTR asks for the data from a Resource Abstraction Interface (RAI) which provides energy consumption and generation, log of devices states including with the latest state and weather realisation and prediction. All the data is provided for the period requested. Weather predictions horizon is dependent on source of the weather forecast. The DTR uses the data to predict consumption, generation, state and occupancy of the household in the prediction horizon. Predictions are returned to the AFM.

If optimisation per prices is set in the user preferences the AFM obtains tariffs and prices from Tariffs&Prices Interface, a component external to the project. The interface returns the tariffs and prices valid for the prediction horizon.

The AFM calculates an optimal array of set-points for the heating equipment in the household for the horizon period. The optimisation takes into account the predictions provided by the DTR and optimisation preferences.

If manual operation is set in user self-optimisation preferences the user is asked for consent to the schedule. The schedule can be reviewed and confirmed.

On the end of the cycle, if the preferences allow automated schedules or the schedule has been confirmed, the setpoints schedule is prepared and published by AFM. Published set-points schedule can be accessed by other components if needed. The schedule is invoked through the RAI which in turn invokes all the set-point schedules prepared.

The schedule is valid till the next cycle execution. The cycle as described repeats and if new schedule can be applied it is applied and all previous scheduled set-point changes removed.

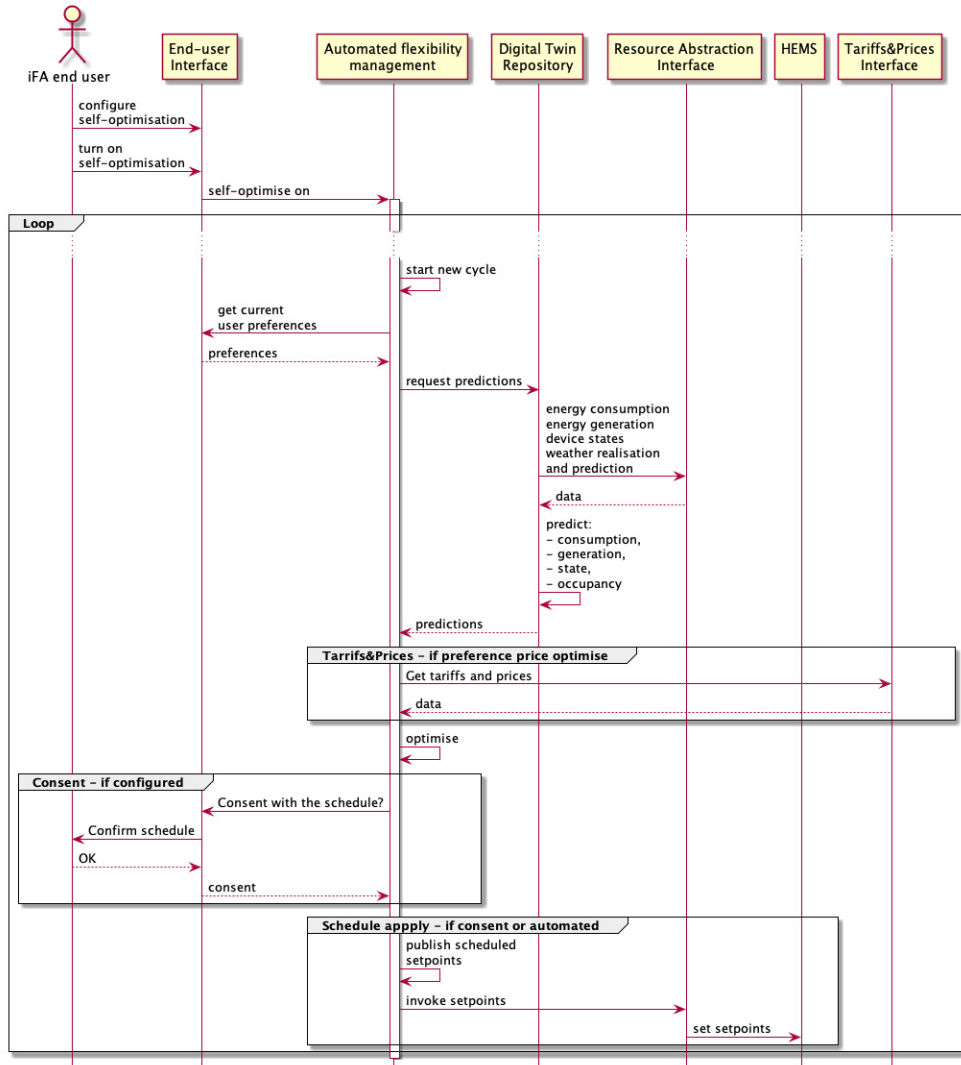

Figure 31: Increase self-balancing through forecasting and automation.

4.1.2.7 Trust, security and privacy perspective

Trust between end-users and iFA is established through the process shown in Figure 32. First, the end-user has to create their own digital identity. Underlying concepts, describing how this is achieved, are explained in the deliverable D4.7 – Initial secure consumer data management module. This identity is then presented to the Trust Module in the iFA, with a proof of participation in the iFA project (a token, provided to them in the initial project invitation). The Trust Module checks whether the presented information correlates with the manually inserted information in the iFA. If the information is correct, an end-user account is created and linked to a predefined data in the data controller. Relevant access control policies are created in the Security and Privacy Module. The end-user is issued a credential, containing attribute claims, which are used in all succeeding communications to authenticate and authorize the end-user. Upon the end-user’s request to access a specific resource, the issued credential and identity is passed along with the request. The Security and Privacy Module uses this information to decide whether the end-user can access the requested resource. If the access is allowed, the end-user receives is permitted the access to resource.

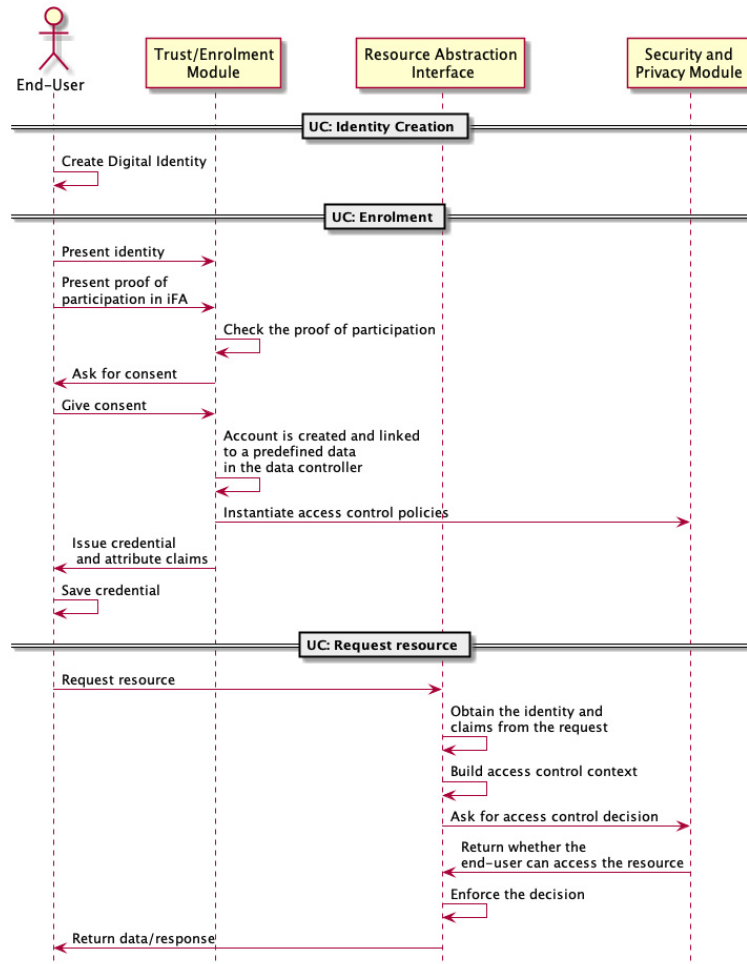

Figure 32: Process of end-user identity creation, enrolment and resource request.

4.2 Architecture of an iFLEX Assistant for a building community

This section introduces a system architecture for an apartment building iFA designed for the Finnish pilot. The iFA for a building community is associated to the following Business Use Cases and High Level Use Case:

- BUC-3: Offer the flexibility of a multi-vector energy system (building community) to the energy markets.
- BUC-4 - Optimal energy consumption for multi-vector energy system (building community) based on the behaviour of consumers and market price signals.
- HLUC-3: Manage flexibility requests or price signals at building level.

The main goal of this iFA is to automate the flexibility management in an apartment building where the costs of HVAC, domestic hot water, and electricity for common areas are paid collectively by the building community (also known as building association). So instead of serving a single family the iFAs serves the whole building community.

4.2.1 Context view

Figure 33 illustrates the context view of the iFA to be developed for the building community in the second phase of the project. This iFA in serving the whole building community and it has two types of end-users: Residents and Facility manager.

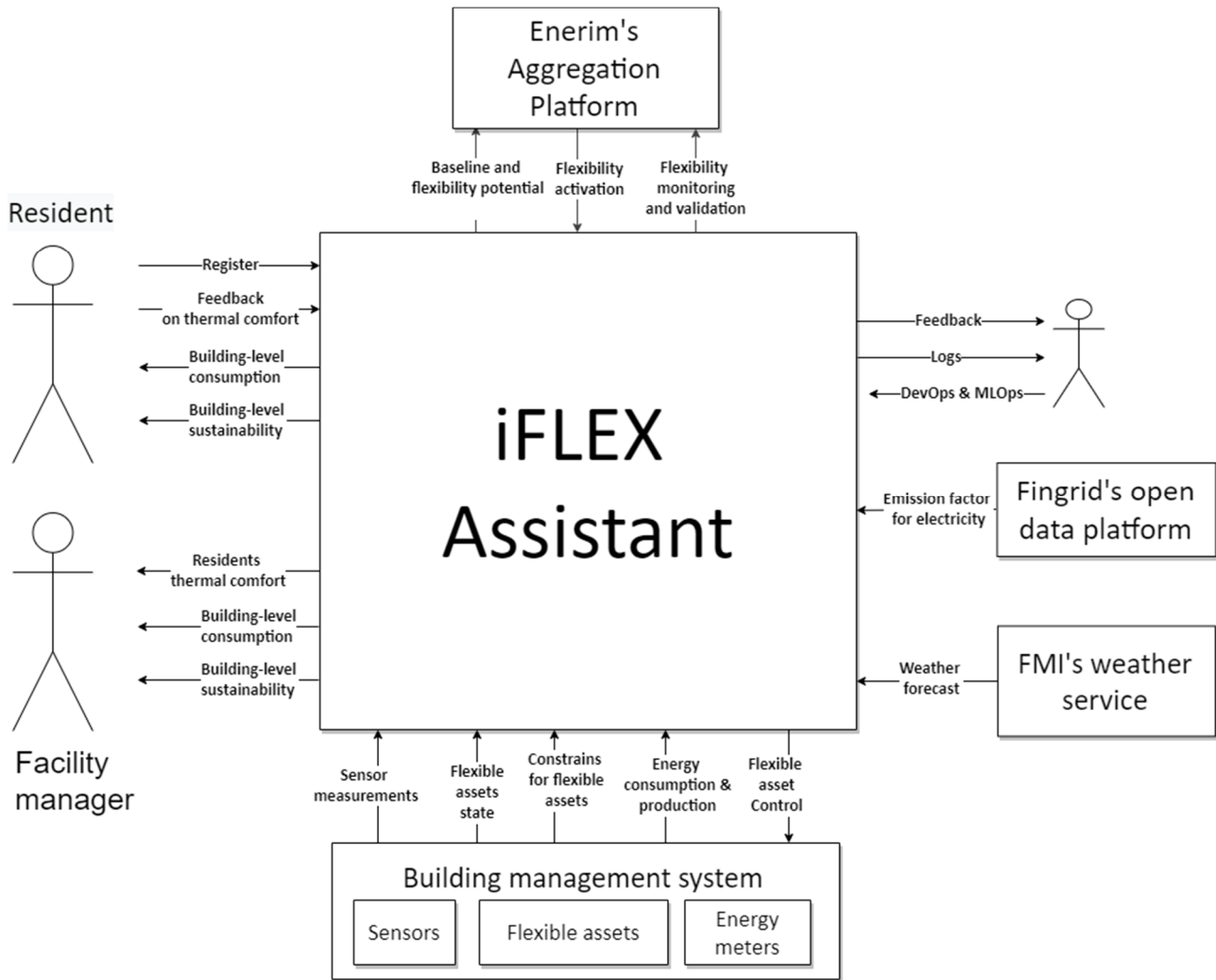

Figure 33: Context view of the iFLEX Assistant to be customized for the apartment building (FIN pilot).

The Facility manager is an entity responsible for ensuring functionality and comfort in the apartment building. The iFA for phase 2 provides the facility manager with three types of visualizations:

- First, it visualizes the historical energy consumption both for electricity and district heating at the apartment building level.
- Second, the assistant provides estimates on CO2 footprint of the apartment building. Both electricity and district heating vectors are included.
- Third, it provides the facility manager with visualizations on the resident's thermal comfort. The thermal comfort of residents includes three types of information: 1) temperature and humidity measurements, individual thermal sensation index that maps the temperature and humidity into individual body type of a person, and feedback on thermal provided by the residents.

It should be noted that there is no interface for providing constraints and preferences for temperatures and other measurements as this type of information is fetched directly from the Building Energy Management System of the apartment building.

Residents are iFA's end-users that live in the apartment building. The iFA provides residents with visualization on the building-level energy consumption and sustainability metrics (i.e., CO2 footprint). Residents can also provide feedback on their thermal comfort via the iFA. This feedback is provided to the facility manager as well as utilized by the iFLEX support team to further improve the iFA. Residents can also access results on the DR events executed at the apartment building level.

The main extensions to the first phase architecture are the Aggregation Platform provided by Enerim that is integrated with the iFLEX Assistant. Other important external systems for the iFA include the Building Energy

Management System, Weather Service provided by Finnish Meteorological Institute (FMI), and Fingrid Open Data platform, which is used for accessing estimated CO2 emissions for the electricity consumed in Finland.

4.2.2 Functional view

The functional view architecture of the building community iFA is otherwise identical to the common functional view, depicted in section 3.2, with the only exception being the user interface that is divided into two parts: Resident interface and Facility manager interface.

The interaction between the functional components is further illustrated in sections 4.2.2.1 - 4.2.2.5 that represent the main use cases provided by the iFA in the phase two.

4.2.2.1 PUC-1 - Manage my preferences

This use case focuses on thermal comfort of the residents. The default settings and constraints related to thermal comfort in an apartment building is provided by the BEMS. This information is utilized by the Automated flexibility management component to estimate the amount of flexibility and to optimize flexibility management (please refer to PUC-8 and PUC-9 for further details). The information is accessed via the Resource Abstraction Interface. The associated thermal comfort measurements are also accessed via the RAI. In addition to the raw temperature and humidity measurements, the iFA will model individual thermal sensation of end-users. It is important to provide individual perspective as people with different body types feel thermal comfort in different ways. In practice the individual thermal sensation for different body types will be calculated by the consumer digital twin that is part of the Digital twin repository module. The iFA visualizes the key measurements and the individual thermal sensation for the facility manager to enable continuous monitoring. Figure 34 represents a sequence diagram of the abovementioned interaction between the functional components. Please note that the sequence diagram contains several independent exchanges of information that are visualized in a single diagram as they are thematically interlinked with each other.

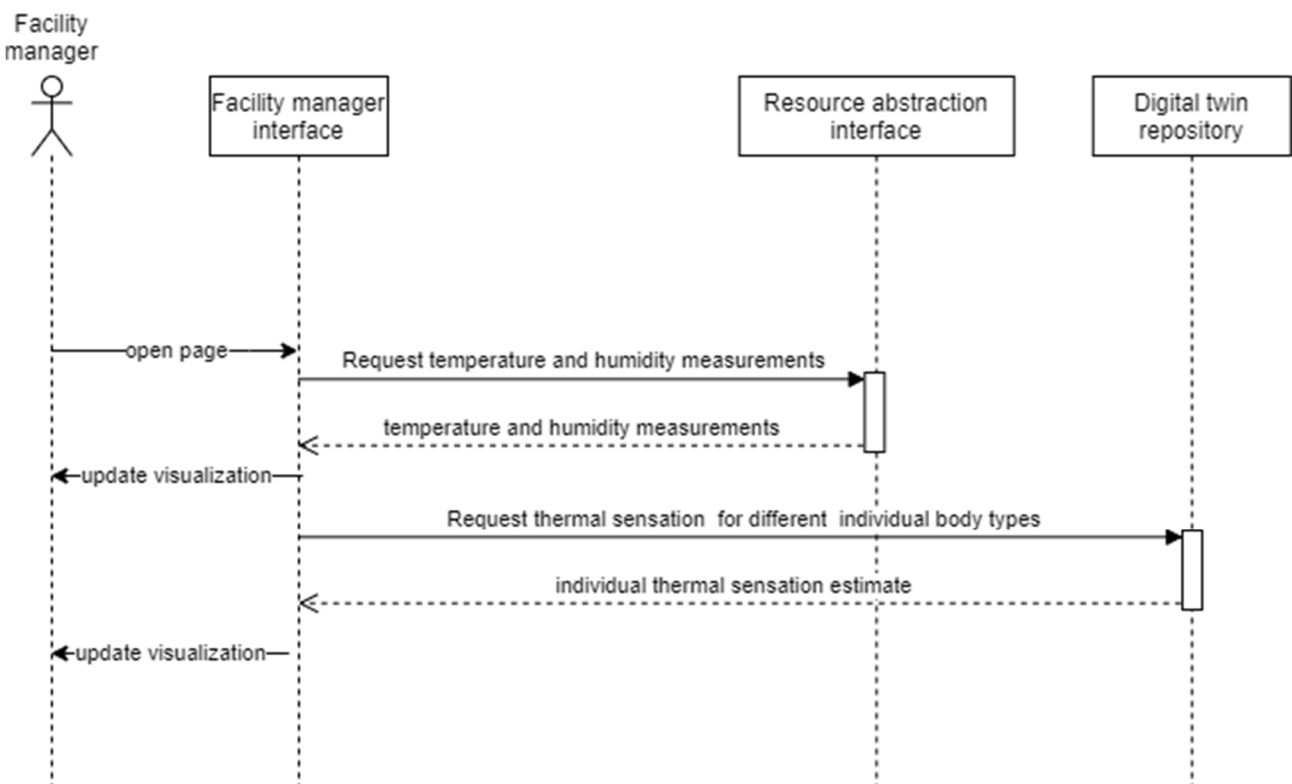

Figure 34: Sequence diagram for collecting and visualizing thermal comfort related data.

In addition to the raw measurement data and the individual thermal sensation estimate illustrated above, end-user feedback is a key part of the thermal comfort monitoring. This feature enables the residents to provide their preference in form of a direct feedback that is measured using thermal sensation index. The feedback is utilized manually by the facility manager and the iFLEX support team. Figure 35 illustrates a sequence diagram of the feedback mechanism.

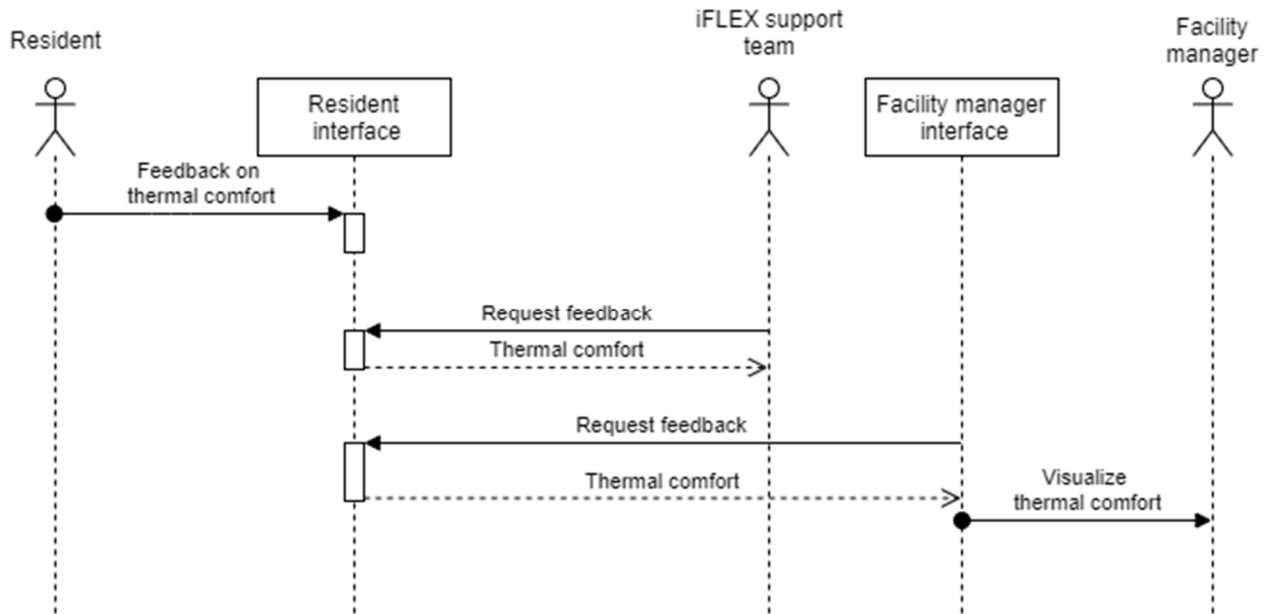

Figure 35: Sequence diagram for feedback on thermal comfort.

Residents are provided with a user interface that enables them to send feedback on their thermal comfort. The feedback is stored into a database of the resident interface, where it can be accessed by the Facility manager interface and the iFLEX Support team. The Facility manager interface visualizes the thermal comfort feedback for the facility manager that is responsible for ensuring the thermal comfort of the residents. This feedback is used for fine-tuning the building automation system. This functionality is outside of the scope of the iFA.

The feedback is also utilized by the iFLEX support team to analyse that the iFA works as expected. To elaborate, this information is used as an additional feedback to the measurement data available via the RAI, to make sure that the thermal comfort is not compromised during the flexibility management. I.e., if correlation between thermal discomfort and flexibility management is identified, the situation will be analysed and corrective actions executed (e.g. improve metering).

4.2.2.2 PUC-3 - Monitor my sustainability metrics

This use case focuses on visualizations of the apartment building-level CO₂ footprint. The footprint is calculated based on CO₂ emission estimates and energy consumption measurements for electricity and district heating. For electricity the CO₂ emission estimates (gCO₂/kWh) are fetched from Fingrid's Open data service that provides high resolution estimates for electricity consumed in Finland. For district heating, similar real-time estimates for CO₂ emissions are not available. For this reason, a static estimate is provided by the iFLEX support team based on the estimate provided by the DH provider. Figure 36 illustrates an example interaction between the functional components responsible for implementing the use case.

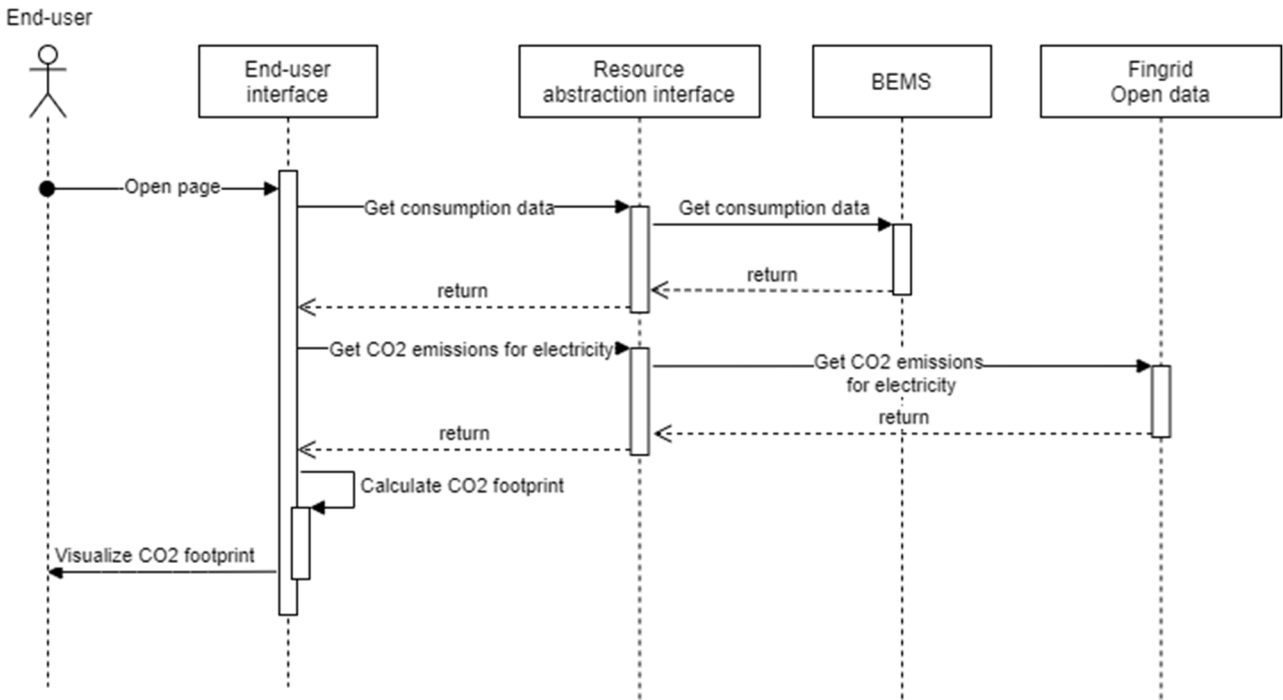

Figure 36: Sequence diagram for monitoring sustainability metrics.

4.2.2.3 PUC-7 - Monitor my energy in real-time

The energy monitoring use case for the building community iFA is straightforward as illustrated in Figure 37. The End-user interface fetches energy consumption data for district heating and electricity consumption from the Resource abstraction interface and visualized it to the end-users. Similar functionality is provided both for Residents and the Facility manager.

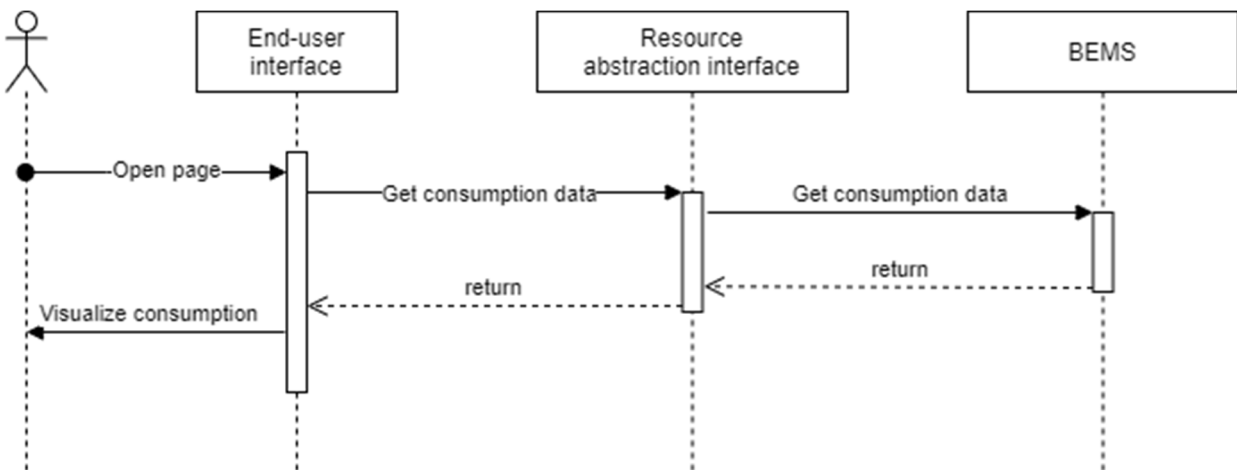

Figure 37: Sequence diagram of energy consumption monitoring use case.

4.2.2.4 PUC-8 - Offer flexibility

The offer flexibility use case to be demonstrated for the building community iFA is depicted in Figure 38.

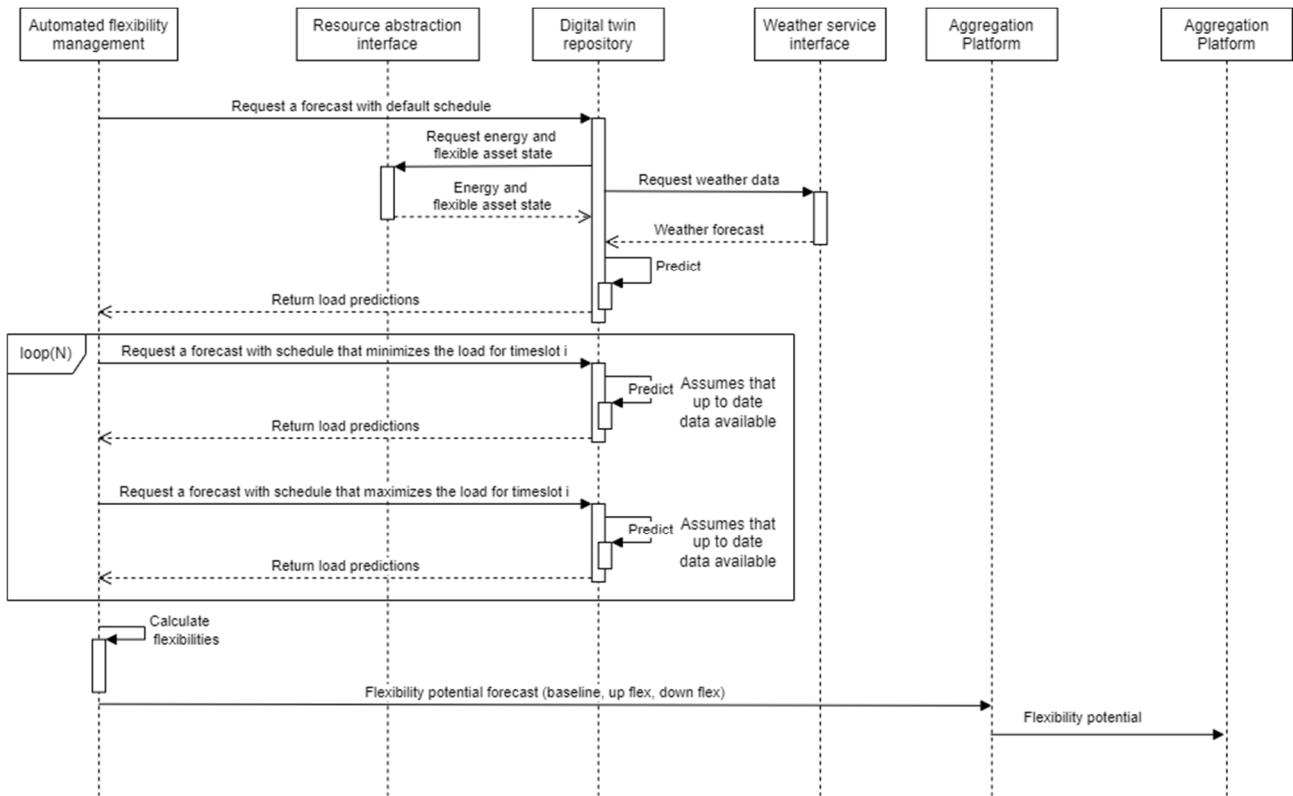

Figure 38: Sequence diagram for the offer flexibility use case.

The Automated flexibility management module is responsible for offering the buildings flexibility to the Aggregator and market interface component. To this end, it requests the Digital twin repository to first perform a forecast on electricity and district heating consumption for a specified time horizon. The first forecast is performed with default set points for the flexible assets.

To perform a forecast the Digital twin repository request latest data (i.e., flexible assets state and energy consumption data) from the Resource abstraction interface component. In parallel, weather forecast data is requested from the weather service interface. This data is then fed as input for the digital twin models providing a forecast for the baseline consumptions (electricity and district heating) and the forecasts are returned to the Automated flexibility management module.

After the Automated flexibility management module has obtained the baseline it will continue to estimate the maximum and minimum loads for each time period. This is again done by requesting energy consumption forecasts from the Digital twin repository. First, the minimum load for each time period is requested. The Digital twin repository does not request new state of weather forecast data since it already has the latest information from the last call. To estimate the minimum load for each time period and for both energy vectors multiple forecasts are required. The details will be presented in D3.2 - Revised hybrid-modelling module and D3.8 - Revised automated flexibility management module. Once the minimum load for each time period and for both energy commodities are forecast the Digital twin repository will return the minimum load forecast to the Automated flexibility management module. The maximum load for each time period is requested and forecast in the same way as the minimum load. Again, it is assumed that the Digital twin repository has the latest information on flexible asset state, energy consumption and weather forecast available.

Once the Automated flexibility management module has obtained the baseline, minimum and maximum loads for both energy vectors, it calculates the flexibility potential by calculating the delta between the different scenarios and the baseline load profile. The information on the flexibility potential (up and down) with baseline is then sent to the A&M Interface that forwards the data to Enerim’s Aggregation Platform. The Aggregation Platform that utilizes the data for optimizing aggregated flexibility management.

4.2.2.5 PUC-9 - Optimize schedule considering prices and/or incentives

The PUC-9 focuses on demonstrating automated flexibility management under implicit and explicit demand response. The implicit demand response optimization targets to reduce the energy and network costs at the apartment building level. These costs depend on the electricity and district heating consumption and the DH

peak load. An example sequence diagram for the implicit demand response is depicted in Figure 39. First, the AFM requests necessary tariff data from the A&M Interface. Then it generates possible schedules that comply with the thermal comfort of the residents (the temperature needs to be at least 21.0 Celsius degree). A simplified optimization is depicted in this example where the AFM utilizes the DTR to predict the load profiles and indoor temperatures for different heating schedules. Then it calculates the energy and network costs and selects the schedule that minimizes the costs while satisfying the constrain for thermal comfort. Finally, the load profile (and schedules) are stored to be used for control.

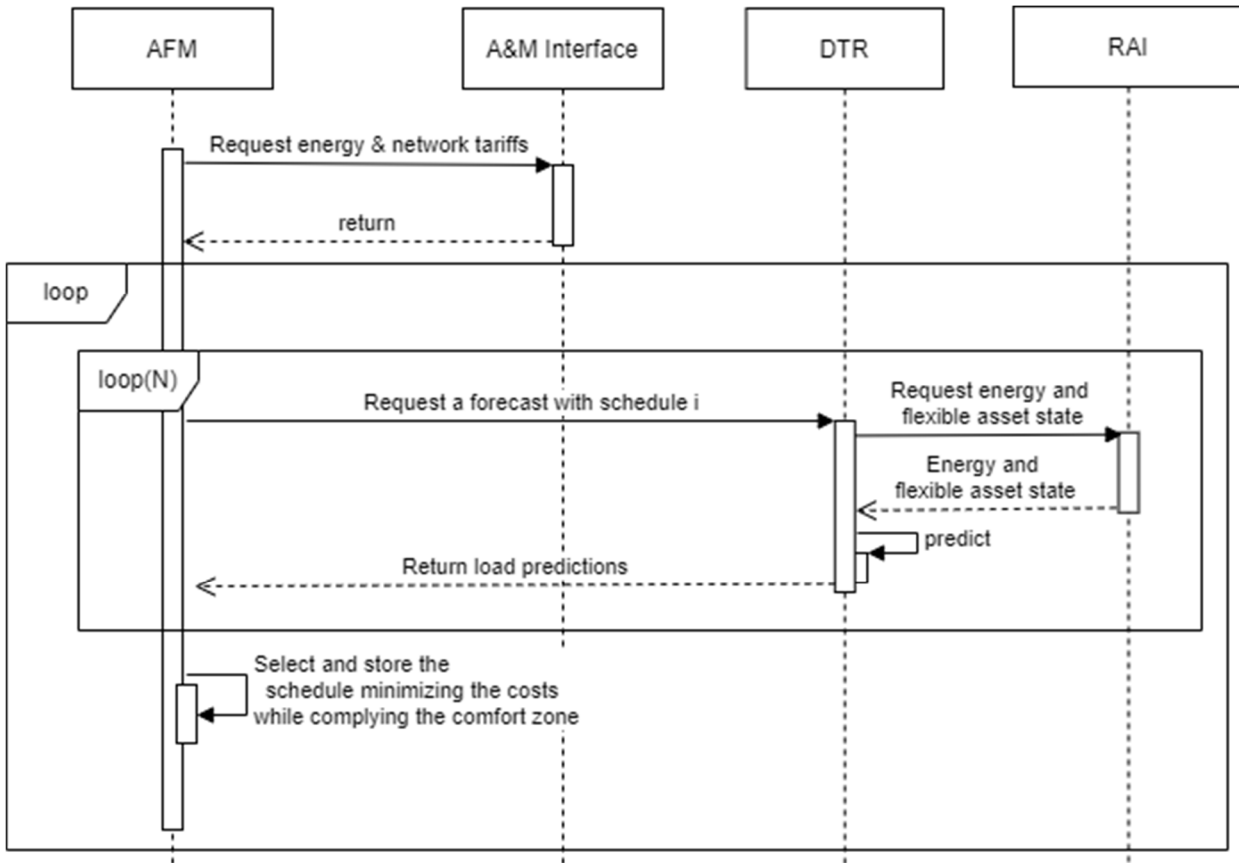

Figure 39: Implicit demand response optimization.

Figure 40 illustrates the interaction of components under explicit demand response. Explicit demand response is realized by activating offered flexibilities (see PUC-8 for details on how the flexibilities are offered) as illustrated in Figure 40. The use case is initiated by the Aggregation Platform that sends the flexibility signal to the iFLEX Assistant. The signal is received by the Aggregator & Market interface module that sends the explicit flexibility activation to the AFM module. The Automated flexibility management module modifies then baseline load profile (optimized as part of the implicit DR) with the flexibility activation. To this end, it utilizes the Digital Twin Repository to estimate the impact. Then it notifies the A&M interface about how the impacts of the requested flexibility activation. Finally, the A&M interface notifies about the Aggregation Platform about the response to the flexibility activation.

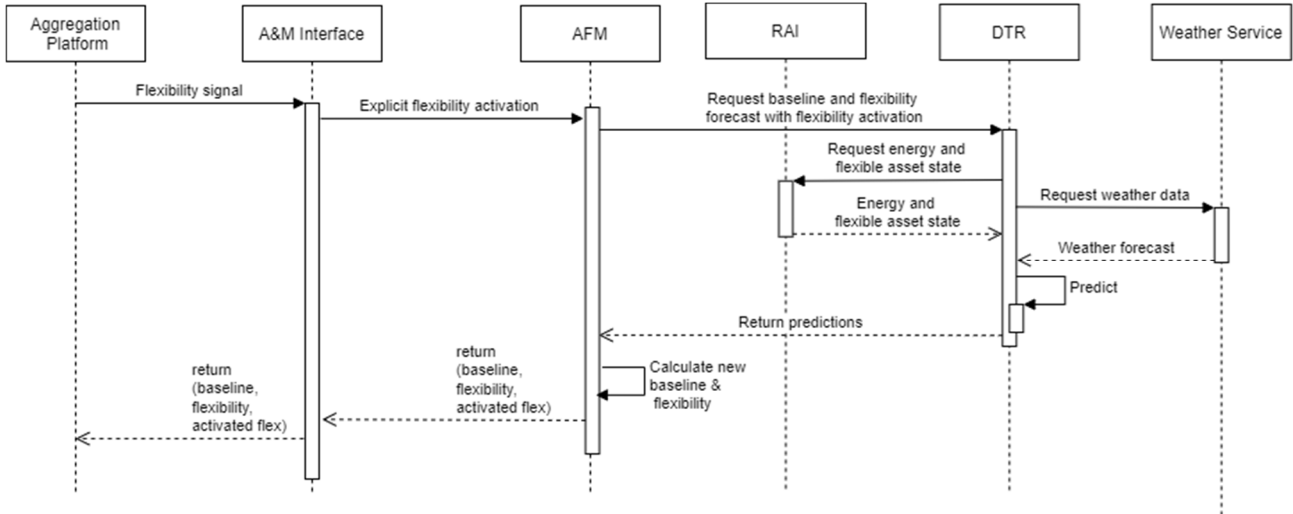

Figure 40: Sequence diagram illustrating a flexibility activation.

The load profile optimized under implicit and explicit demand response is realized with model predictive control as illustrated in Figure 41. The goal of this optimization is to follow the load profile as closely as possible. The optimization is performed at fixed intervals. In practice, there are many ways to optimize a schedule. In this example, the Automated flexibility management requests a forecast for every possible scenario (i.e., brute force) from the Digital twin repository. Similarly, to PUC-8, the digital twin repository fetches the necessary input data from the Resource abstraction interface and the Weather interface components. Once all possible scenarios have been executed the Automated flexibility management component compares the forecasted loads with the baseline load profile and selects the one with minimum deviation. Finally, the new schedule is activated by sending a control command to the RAI.

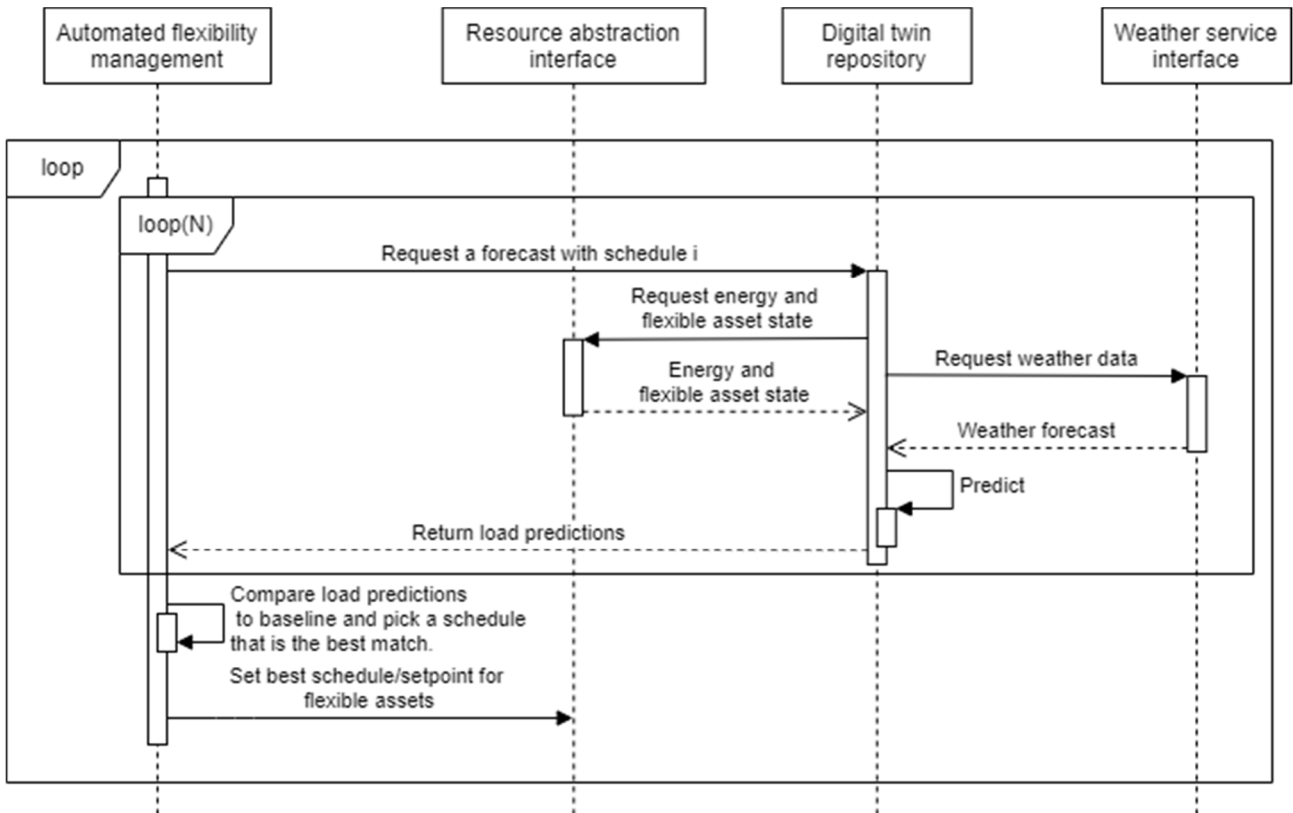

Figure 41: Sequence diagram of schedule optimization for flexible assets.

5 Conclusion

This document describes the common architecture for iFLEX Framework, and its design process. The document represents:

- how iFLEX Framework interacts with end-users, other stakeholders and its environment
- how the logical subcomponents of the framework interact with each other
- how the components process and manage information
- what technologies and standards are used between the iFLEX Framework and external systems, and between functional components, to achieve interoperability
- how to address interoperability, security and privacy in the iFLEX Framework architecture

In addition, this document describes applications of the iFLEX Framework to an iFLEX Assistant targeted to a building community and to households.

6 List of figures and tables

6.1 Figures

Figure 1: The common context view of the iFLEX Framework.....	8
Figure 2: Functional view of the common iFLEX Framework.....	11
Figure 3: Data models for the A&M Interface Module – Flexibility Signal, Validation Data, and Report.....	21
Figure 4: Data models for the A&M Interface Module – Energy tariffs.....	22
Figure 5: Data models for Automated Flexibility Manager interface.....	23
Figure 6: Data models for Digital Twin Repository interface.....	23
Figure 7: Data models for the UI Module – iFLEX Suggestions and User Acceptance.....	25
Figure 8: Data models for the UI Module – Preferences and configurations.....	26
Figure 9: RAI Household information view.....	27
Figure 10: Weather Service information view.....	28
Figure 11: Digital identity and Resource document.....	29
Figure 12: Verifiable credentials and Environment of the access control invocation.....	29
Figure 13: Interoperability dimensions of SGAM (CEN,2012).....	30
Figure 14: Mapping of the interoperability technologies to the functional architecture of the iFLEX Framework.....	31
Figure 15: Context view of the iFLEX Assistant to be customized for the household (SI and GR pilots).....	33
Figure 16: PUC-1 sequence diagram, scenario: Set schedules of assets.....	35
Figure 17: PUC-1 sequence diagram, scenario: Set flexible schedules of assets.....	36
Figure 18: PUC-1 sequence diagram, scenario: Define optimisation policy.....	37
Figure 19: PUC-1 sequence diagram, scenario: Temporarily mute notifications.....	37
Figure 20: PUC-1 sequence diagram, scenario: Mute notifications in recurrent time periods.....	38
Figure 21: PUC-4 sequence diagram, scenario: Present DR benefits.....	39
Figure 22: PUC-4 sequence diagram, scenario: Estimate energy costs.....	40
Figure 23: PUC-4 sequence diagram, scenario: Present optimisation benefits.....	41
Figure 24: PUC-4 sequence diagram, scenario: Present benefits from iFA's operation.....	42
Figure 25: Monitoring of household consumption close to real time.....	43
Figure 26: Sequence diagram illustrating the flexibility offering PUC.....	43
Figure 27: Sequence diagram depicting the implicit DR optimization.....	44
Figure 28: Sequence diagram illustrating explicit DR signal and schedule optimization without a need for explicit acceptance from the End-user.....	45
Figure 29: Sequence diagram illustrating explicit DR signal and schedule optimization with explicit acceptance from the End-user.....	45
Figure 30: Sequence diagram illustrating the scheduling of flexible assets.....	46
Figure 31: Increase self-balancing through forecasting and automation.....	47
Figure 32: Process of end-user identity creation, enrolment and resource request.....	48
Figure 33: Context view of the iFLEX Assistant to be customized for the apartment building (FIN pilot).....	49
Figure 34: Sequence diagram for collecting and visualizing thermal comfort related data.....	50
Figure 35: Sequence diagram for feedback on thermal comfort.....	51
Figure 36: Sequence diagram for monitoring sustainability metrics.....	52
Figure 37: Sequence diagram of energy consumption monitoring use case.....	52
Figure 38: Sequence diagram for the offer flexibility use case.....	53
Figure 39: Implicit demand response optimization.....	54
Figure 40: Sequence diagram illustrating a flexibility activation.....	55
Figure 41: Sequence diagram of schedule optimization for flexible assets.....	55
Figure 42: Sequence diagram for communicating flexibility validation data to the market.....	60
Figure 43: Sequence diagram for activating flexibility and generating report on flexibility request in the Greek pilot.....	61

6.2 Tables

Table 1: Description of elements of the context view.....	8
Table 2: Functional elements of the common iFLEX Framework.....	11
Table 3 Resources of the A&M interface.....	14
Table 4: Logical interface of the Automated Flexibility Manager.....	15

Table 5: Logical interface of the Digital Twin Repository.	15
Table 6 Resources of the UI Module	15
Table 7: Logical RAI interfaces.....	16
Table 8: Logical weather interface.....	17
Table 9: Logical interface of the Security, Trust and Privacy Interface.	17
Table 10: The data elements of iFLEX Assistant.	17
Table 11: The description of data items.	18
Table 12: Data objects relevant to the A&M Interface Module.....	20
Table 13: Logical interface of the Automated Flexibility Manager.....	22
Table 14: Logical interface of the Digital Twin Repository.	23
Table 15: Data objects relevant to the UI Module	24
Table 16: Logical interface of the RAI model	27
Table 17: Weather Service information view	27
Table 18: Information data items for the Trust, Security and Privacy Interface	28
Table 19: Technologies and standards for different interoperability layers.....	30

7 References

- (CEN,2012) CEN-CENELEC-ETSI Smart Grid Working Group Reference Architecture, 'Reference Architecture for the Smart Grid' (SGCG/M490/C_Smart Grid Reference Architecture), Brussels, 2012
- (Council, 2008) Council, G.A. 2008. GridWise Interoperability Context-Setting Framework. Smart Grids Interoperability, 1-52.
- (Daniele, 2020) Daniele L. SAREF4ENER: an extension of SAREF for the energy domain created in collaboration with Energy@Home and EEBus associations. 2020. Online, access 25th of April 2022: <https://saref.etsi.org/saref4ener/>
- (ISO, 2011) ISO/IEC/IEEE 42010:2011 - Systems and software engineering - Architecture description. International Organization for Standardization. 2011-11-24.
- (Jennings et al., 2018) Jennings C., Shelby Z., Arkko J., Keranen A. and Bormann C. Sensor Measurement Lists (SenML), RFC 8428, Standards track. 2018. Online, accessed 25th of April 2022: <https://datatracker.ietf.org/doc/rfc8428/>
- (Rozanski and Woods, 2014) Nick Rozanski, Eoin Woods, Software Systems Architecture: Working with Stakeholders Using Viewpoints and Perspectives, Pearson Education, Limited, 2014, 576 p.

8 Appendix

Use Case: Communicate flexibility validation data to the market

Necessary data are communicated by the iFA to the Aggregation Platform, so that the iFA end-user's participation in explicit DR events can be validated. Once an explicit DR event, in which the end user opted in, has been completed, the flexibility validation data are retrieved by the A&M Interface Module from the RAI. The information model of the flexibility validation data depends on the type of the explicit DR program. Depending also on data availability, potential candidates are either energy measurements from submeters of specific assets or the status of operation of these assets, as provided by dedicated devices. Then, the A&M exploits the flexibility validation data in order to assess the participation of the iFA end user in an explicit DR event and subsequently sends the outcome to the Aggregation Platform. This DR participation assessment can be offered by the iFA to Aggregators as a value-added service. Alternatively, the actual flexibility validation data can be sent to the Aggregation Platform, so that the compliance of the users' actions with the DR event's requirements is evaluated by the Aggregator itself. Finally, the Aggregation Platform generates a flexibility report and sends it to the iFA.

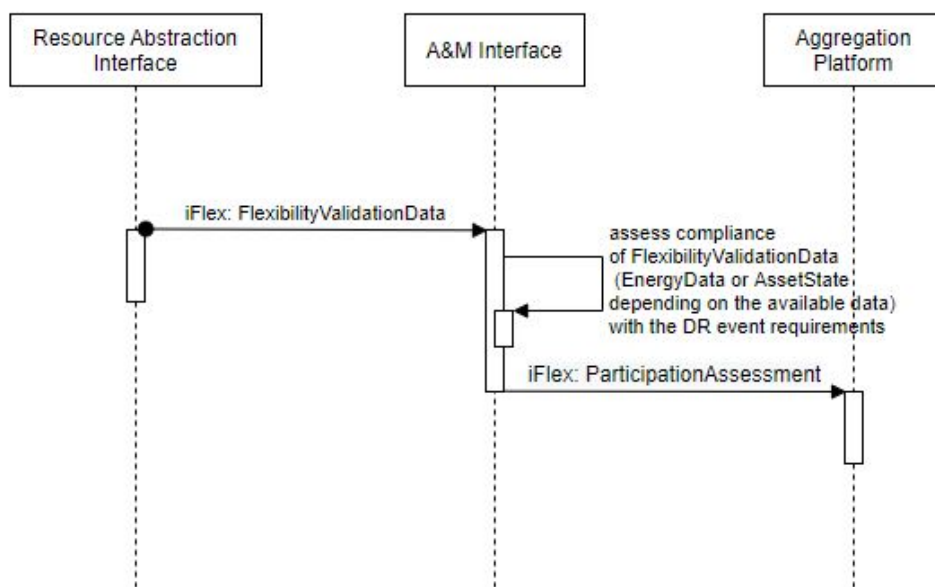

Figure 42: Sequence diagram for communicating flexibility validation data to the market

Use Case: Flexibility activation and report on flexibility request

This Use Case (UC) describes the process related to activating flexibility in the Greek pilot, as well as to generating a report on the submitted flexibility request. More specifically, this flexibility request is submitted to the Demand Response Management System (DRMS) by a Balance Responsible Party (BRP) Management System. The BRP asks for flexibility in order to balance its position in the energy market, and a DR Aggregator offers this service to the BRP via the operation of the DRMS. Subsequently to the submission of the flexibility request from the BRP Management System, the DRMS calculates appropriate DR event(s) in order to aggregate the requested flexibility. Then, relevant flexibility signals are sent by the DRMS to the iFAs of the selected pilot users, who can decide whether to participate or not in the DR event. After the end of the DR event(s), the flexibility offered by the iFA end users is validated by the DRMS, which assesses the compliance of the iFA end users' actions with the DR event's requirements. Then, statistics for the dispatched DR event(s) are calculated and a report on the efficiency of the provided service is generated by the DRMS, so that the BRP Management System can receive it upon request. Hence, the BRP Management System Operator can read the report and evaluate the efficiency of the service provided by the DR Aggregator via the DRMS in response to the submitted flexibility request.

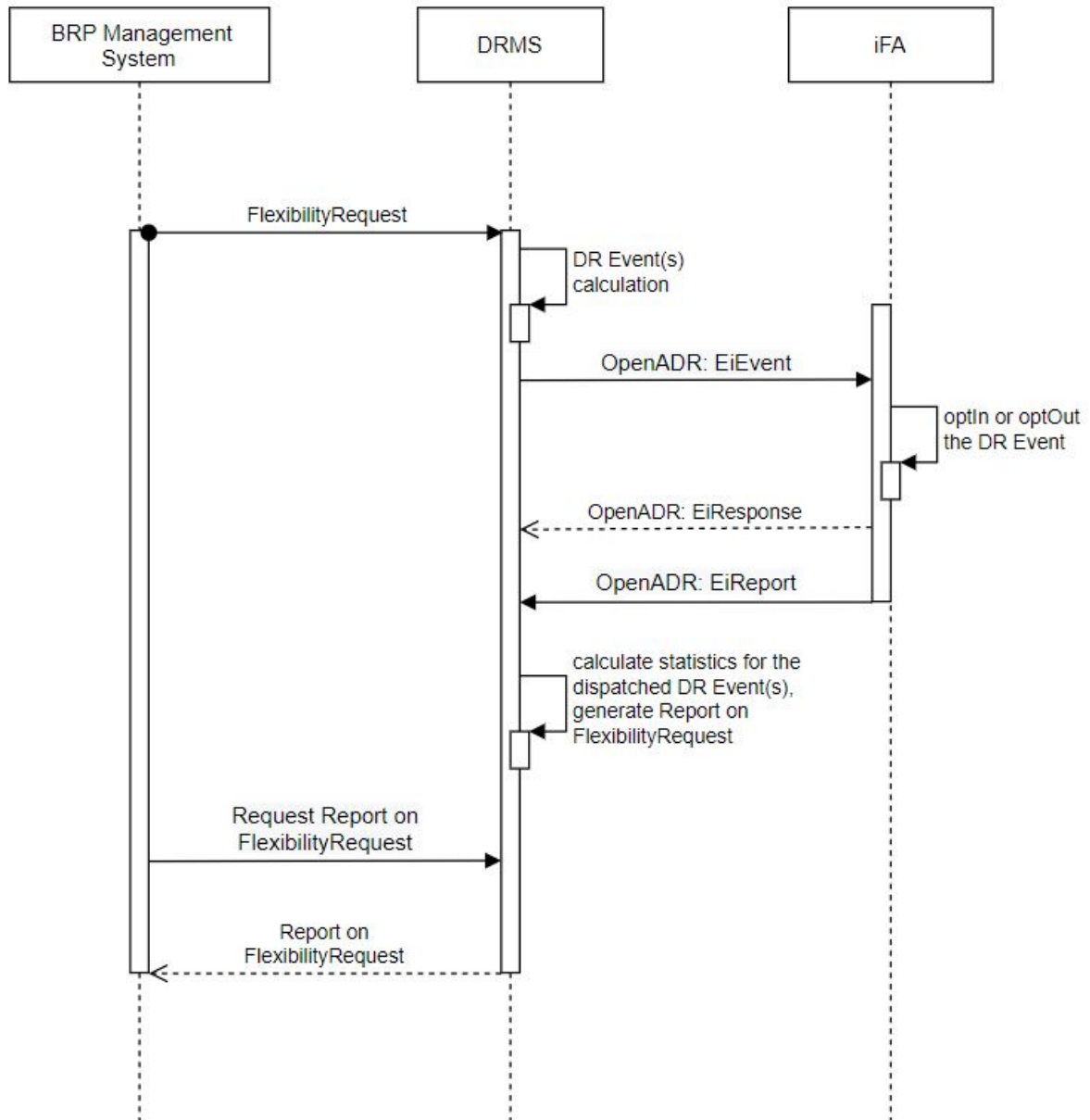

Figure 43: Sequence diagram for activating flexibility and generating report on flexibility request in the Greek pilot.